



ANGOON AIRPORT



Scoping Report

March 2018

Prepared for

State of Alaska
Department of Transportation
& Public Facilities

Southcoast Region
Design & Engineering Services

Prepared by

PDC ENGINEERS
6205 Glacier Highway
Juneau, Alaska 99801
T: 907.780.6060 | F: 907.780.4611

TABLE OF CONTENTS

1	INTRODUCTION	1
1.1	Scope	1
1.2	Project History	1
1.3	Purpose and Need	2
1.4	Proposed Action	2
2	EXISTING CONDITIONS	3
2.1	Airport Facilities.....	3
2.2	Community Characteristics.....	3
2.3	Community Development Plans	4
2.4	Land Use and Land Ownership	4
2.5	Available Utilities	4
2.5.1	Communications.....	4
2.5.2	Electricity.....	4
2.5.3	Water/Wastewater	4
2.5.4	Solid Waste Generation and Disposal	4
3	UPDATED AVIATION ACTIVITY AND FORECAST.....	4
3.1	Forecast Elements	4
3.2	Forecast Summary	5
4	FACILITY REQUIREMENTS	6
4.1	Design Aircraft	7
4.2	Wind Coverage	7
4.3	Airfield Requirements.....	8
4.3.1	Runway Length.....	8
4.3.2	Runway Capacity	8
4.4	Taxiway	9
4.5	Navigational Aids and Airfield Lighting.....	9
4.6	Airport Access Road.....	10
4.7	Other Requirements	10
5	ENVIRONMENTAL REVIEW	11
5.1	Public Involvement	11
6	LAND STATUS	12
7	ALTERNATIVES.....	13
7.1	Initial Development	13
7.1.1	Design Criteria	13
7.1.2	Initial Concepts.....	13
7.1.3	Initial Concept Analysis	14
7.2	Alternative Refinement and Evaluation Process	15
7.2.1	Dropping of Alternative 12A-Alpha	17
7.2.2	Dropping of Alternative 12A-Charlie	17
7.2.3	Alternative 12A-Echo.....	18
7.3	Alternative 12A-Echo to be Carried Forward	18
8	GEOTECHNICAL.....	19
8.1	Subsurface Materials.....	20
8.2	Geologic Hazards	20

8.3	Material Sites.....	20
9	HYDROLOGIC AND HYDRAULIC ANALYSIS	20
9.1	Alternative 12A-Alpha	20
9.2	Alternative 12A-Charlie	21
9.3	Alternative 12A-Echo.....	21
9.4	Groundwater	22
10	CONCEPT-LEVEL COST	22
11	DATA GAPS AND ANALYSIS.....	22

FIGURES

Figure 1	– Angoon and Potential Airport Alignments at Site 12A.....	3
Figure 2	– Wind Coverage.....	7
Figure 3	– 10/3/17 Public Meeting	11
Figure 4	– General Land Ownership from EIS	12
Figure 5	– Concept Layouts.....	14
Figure 6	– Alternatives A, C, E Layout	16
Figure 7	– Approach Analysis of South End	16
Figure 8	– Alternative 12A-Echo	18
Figure 9	– Initial Draft of Proposed ROW Boundary	19

TABLES

Table 1	– Forecast Operations at (Prospective) Angoon Land-Based Airport	6
Table 2	– Allowable Crosswind Components by Aircraft Design Group	7
Table 3	– Runway Dimensional Standards for Various Scenarios.....	8
Table 4	– Taxiway and Taxilane Design Dimensions Based on Aircraft Design Group (per AC 150/5300-13A, Table 4-1).....	9
Table 5	– Access Road Design Criteria Based on AASHTO Guidelines for Geometric Design of Very Low-Volume Local Roads, 2001	10
Table 6	– Example Southcoast Airport Apron Sizes	10
Table 7	– Key Dimensional Standards.....	13

APPENDICES

- Appendix A – Forecast and Facility Requirements Information
- Appendix B – Public Involvement Plan
- Appendix C – Location Study
- Appendix D – Hydrologic and Hydraulic Considerations
- Appendix E – Alternatives
- Appendix F – Geotechnical Considerations
- Appendix G – Cost Estimate

1 INTRODUCTION

The State of Alaska Department of Transportation and Public Facilities (DOT&PF) has retained PDC Engineers (PDC) to lead planning studies, design support for environmental requirements and right-of-way (ROW) acquisition, and design for a new land-based airport at Angoon, Alaska. As part of the proposed project, HDR is providing hydrologic and hydraulic modeling, public involvement, environmental permitting support and access road design, and Mead and Hunt is providing airspace and approach analysis.

Angoon is the only permanent settlement on Admiralty Island and is located about 55 miles south of Alaska's capital, Juneau. The community of Angoon is currently accessible only by seaplane and ferry. These options do not provide sufficient availability and reliability in transportation to and from Angoon. DOT&PF proposes to construct a new land-based airport to improve the availability and reliability of transportation services. The new airport, which would accommodate small, wheeled aircraft, would include a single runway with an apron comparable to other rural airports in Southeast Alaska. Runway lighting would allow a pilot to land at night or during low-light condition. The development of instrument approaches would allow the pilots to navigate to and land at the new airport during instrument meteorological conditions (currently not an option).

1.1 Scope

The scoping phase of the project included:

- Review of historical information
- Coordination with the community
- Field reconnaissance
- Collection and evaluation of data that would potentially impact airport development (land status, wind data, aircraft operations, terrain obstructions, topography, and environmental)
- Identification of potential changes in environmental impacts from the Environmental Impact Statement (EIS) due to design refinements
- Initial geotechnical evaluation
- Initial hydrologic analysis
- Communication with DOT&PF functional groups to evaluate design elements
- Development and evaluation of airport alternatives
- Identification of ROW impacts
- Preparation of probable costs for the new airport
- Identification of data gaps

This scoping summary report documents this effort and recommends one alternative, Alternative 12A-Echo, considered reasonable and practicable for further consideration as the project moves forward for development of the Airport Layout Plan (ALP) and detailed design. Echo is a variation of the EIS preferred alternative (12A).

1.2 Project History

A land-based airport at Angoon has been a goal for DOT&PF and the community of Angoon since the 1980s. The Angoon Airport Reconnaissance Study (February 1983) recommended a site that was not favored by the community. The Angoon Airport Reconnaissance Study (April 2004) recommended a different site than the proposed site and was supported by the community. The Angoon Airport Master Plan (May 2007) was developed for a new airport at that site.

An EIS was prepared for evaluation of various airport alternatives, and the Federal Aviation Administration (FAA) record of decision (ROD) documents the selection of Alternative 12A as the environmentally preferred alternative. This location is approximately two miles southeast of the community, with a runway oriented northwest-to-southeast located west of an existing road to the water reservoir (BIA Road).

The purpose and need as well as the proposed action are based on the EIS and the ROD. The FAA is responsible for the accuracy of all information in the EIS and the ROD. The ROD is available online at FAA's electronic ROD repository (http://www.faa.gov/airports/environmental/records_decision/).

1.3 Purpose and Need

Current transportation service to and from Angoon is solely by seaplane and ferry. These options do not provide sufficient availability and reliability in transportation to and from Angoon. A land-based airport will improve the availability and reliability of aviation transportation services to and from Angoon.

A land-based airport with runway lights, an instrument approach procedure, and a fixed threshold will improve the availability of aviation service to Angoon, allowing flights to occur 89%–94% of the total hours in a given year. This more than doubles the 44% of hours per year that seaplane service is currently available.

1.4 Proposed Action

DOT&PF proposes to construct a new land-based airport that would accommodate small, wheeled aircraft, and would include a single runway with an apron comparable to other non-certificated rural airports in Southeast Alaska. The components of the proposed action as initially proposed include the following:

- Runway: Paved; 3,300 feet long and 75 feet wide, with future expansion capability to 4,000 feet long
- Runway safety areas (RSAs): 150 feet wide, centered on runway centerline, extending 300 feet beyond each runway end
- Runway protection zone (RPZ): Minimum dimensions of 500 x 1,000 x 700 feet
- Runway lights: Pilot-controlled, medium-intensity lights
- Electrical control building
- Single, perpendicular taxiway: Paved
- Terminal space: Sufficient area for a future terminal or passenger shelter and parking
- Aircraft apron: Paved
- Lease lots: 62,500 square feet available for leasing
- Access road: Paved, with two 9-foot-wide lanes and 1-foot shoulders minimum
- Support facilities: Future weather station, weather cameras, communication, wind cones, etc.
- Overhead utility lines: Power and telephone lines located within the access road corridor
- Navigational aid: Rotating beacon
- Visual approach aid: Precision approach path indicator (PAPI)

2 EXISTING CONDITIONS

2.1 Airport Facilities

Much of the information in Sections 2.1 – 2.5 is extracted from the 2016 Angoon Airport EIS, with updates as known.

Currently, the only fixed-wing airplane service to and from Angoon is provided by seaplanes using the Angoon Seaplane Base. The seaplane base is a dedicated dock located in the tidally influenced Favorite Bay. There is no defined seaplane landing area in Favorite Bay; pilots take off and land in the most advantageous area based on water, wind, and weather conditions at the time. Commercial seaplane flights are offered between Juneau and Angoon two or three times daily, depending on the season but does not provide sufficient aviation availability and reliability of service. Seaplane service to and from Angoon is available approximately 44% of the hours in any given year.

2.2 Community Characteristics

Angoon is the only permanent settlement on Admiralty Island. The community is located about 55 miles south of Alaska’s capital, Juneau, and about 700 miles east-southeast of Anchorage, Alaska’s largest city and the location of many state government offices. The 2010 U.S. Census population estimate for Angoon was 459. The community is located on a peninsula surrounded on the west by Chatham Strait and on the north and east by Favorite Bay. Just beyond Favorite Bay to the north, east, and south is the nearly 1-million-acre Admiralty Island National Monument and Kootznoowoo Wilderness Area. Angoon’s environment is characterized as a temperate rain forest, which for this area means high rainfall (60 inches per year on average) and large populations of relatively few species of trees, such as Sitka spruce and hemlock. Angoon is an incorporated city with a democratically elected city government. It has no land-based airport, nor any roads to any other communities. Residents and travelers reach Angoon only by seaplane, by private or charter boat, or by the Alaska State Marine Highway (ASMH) ferry system.



Figure 1 – Angoon and Potential Airport Alignments at Site 12A

2.3 Community Development Plans

Several contacts have been made with the community during the EIS process as well as during the scoping phase. One project was identified that will need to have ongoing coordination. The Inside Passage Electric Cooperative (IPEC) is the Angoon electric utility. Kootznoowoo, Inc., in coordination with IPEC, is pursuing development of a remote hydroelectric project north of the community at Thayer Creek. The project is coordinating airport power needs with IPEC and Kootznoowoo to ensure adequate power will be available once the airport is constructed.

2.4 Land Use and Land Ownership

The land surrounding the proposed airport is undeveloped. Ownership is a mix of private landowners, Native allotments, and corporation, city, and state lands.

2.5 Available Utilities

2.5.1 Communications

There are telephone lines extending from the village on Aukta Street toward the proposed airport site. A telephone line extension of up to 3,000 feet from a takeoff point on Aukta Street will be required to serve the airport.

2.5.2 Electricity

Electricity to the airport will be provided from the Angoon power plant, owned by IPEC. The Angoon power plant is furnished with three Caterpillar diesel generator sets with total plant generating capacity of 1,575 kW and peak winter load of approximately 300 kW. A 12,470 volt, three-phase/7,200 volt, single-phase powerline extension of up to approximately 3,000 feet from a takeoff point on Aukta Street will be required to serve the airport.

2.5.3 Water/Wastewater

There are no water or wastewater facilities in the area of the proposed airport, and these utilities will not be extended to the airport.

2.5.4 Solid Waste Generation and Disposal

The community operates a solid waste facility approximately ½ mile north of the proposed airport.

3 UPDATED AVIATION ACTIVITY AND FORECAST

An updated aviation activity and forecast memorandum was prepared and provided to DOT&PF. The full memorandum is included as Appendix A. Below are some general findings from the memo.

3.1 Forecast Elements

The level and type of aviation activity anticipated at an airport, as well as the nature of the planning to be done, determine the factors to be forecast. The process for updating the forecast included:

- Review of previous forecasts
- Evaluation of previous and current operations, enplanements as well as freight and mail
- Identification of factors that affect operations such as economic activities, population, tourism, commercial fishing, seafood processing and medevacs
- Identification of the design aircraft for consideration of runway length and dimensional standards

3.2 Forecast Summary

Angoon (2016 population: 444) is an Alaskan Native majority community that is geographically isolated, has a population of less than 1,000, is accessible by ferry in southeast Alaska, and has an existing seaplane base. As part of this forecast, a comparison of the annual operations of three communities in southeast Alaska that generally fit into the aforementioned category of characteristics and which have an operating land-based airport. These communities are Hoonah, Kake, and Klawock.

Hoonah (2016 population: 745): Hoonah's land-based airport generated 13 aircraft operations per resident in 2015, for an annual total of 9,855 operations. Using the same rate for Angoon's current population of 444, a base year of 5,772 operations is estimated. Hoonah's annual seaplane base aircraft operations are considerably lower than Angoon's (in Hoonah, 1 operation for every 4 residents, and in Angoon, 4 operations for every 1 resident). With a land-based airport, we can reasonably expect land-based aircraft operations to supplant most seaplane operations, except for those operations which require the capabilities of a seaplane.

Kake (2016 population: 563): Kake's land-based airport generated 8 aircraft operations per resident in 2015, for an annual total of 4,576 operations. Using the same rate for Angoon's current population of 444, a base year with 3,552 operations is estimated. Kake's annual seaplane base aircraft operations are considerably higher than Hoonah's (and lower than Angoon's) with approximately 1 operation for every 1 resident annually.

Klawock (2016 population: 796): Klawock's land-based airport generated 5.3 aircraft operations per resident in 2015, for an annual total of 4,160. Using the same rate for Angoon's current population of 444, a base year with 2,353 operations is estimated. There are zero recorded 2015 operations for the seaplane base.

An analysis of the limited socioeconomic data for these communities reveals a weak link between population/demographics and aircraft operations. The two most relevant factors in operations per population are accessibility to regular ferry service (by access road to another community or locally) and tourist demand.

Kake is an isolated community but with an undeveloped tourist infrastructure and a relatively undesirable natural environment for tourists. Kake's geographic isolation makes regular ferry service infeasible, so the community relies mostly upon air transport.

Klawock is less geographically isolated than our other examples, being just 5 miles north of Craig (population: 1,231 in 2016), with access by road to other major communities and ports on Prince of Wales Island. It also has regular, reliable ferry service. Although Klawock, Craig, and Prince of Wales Island as a whole are popular tourist destinations, aircraft operations are not necessary nor desirable compared to ferry service.

Hoonah is geographically isolated and is not connected by road to another community. There is access to ferries, but service is unreliable. The city and the island it is a gateway to are popular tourist destinations with well-developed tourist infrastructure.

Table 1 – Forecast Operations at (Prospective) Angoon Land-Based Airport

Operations	Base Year 2016	+5 Years	+10 Years	+15 Years
Air Taxi	4,050	4,653	5,236	5,810
Local GA	0	0	20	50
Itinerant GA	150	170	190	210
Medevac	200	210	220	230
Total Operations	4,400	5,033	5,666	6,300
Annual Growth Rate	--	3%	3%	3%

Based on review of past and updated forecast information, Angoon has characteristics mostly resembling a mixture of Kake and Hoonah. Because of the similarity in ferry service and tourism growth, it is reasonable to assume that annual operations may begin above Kake levels and then grow towards Hoonah levels as the Angoon tourist market matures. With the development of a land-based airport, the eventual basing of local GA aircraft is expected and, consequently, local GA operations will increase. Likewise, with the construction of a land-based airport, the frequency of medevac operations is likely to increase.

Base operations of 4,400 are proposed. There is an anticipated increase in economic activity from a land-based airport to bring Angoon’s population back to pre-2000 levels in the range of 550 to 600 persons, assuming the tourism market matures and the commercial fishing industry becomes sustainable. **Fifteen years from start of airport operations, 6,300 annual operations are forecast.**

4 FACILITY REQUIREMENTS

The facility requirements depend on the critical design aircraft or group of aircraft. Federally funded projects require that critical design aircraft have at least 500 or more annual itinerant operations¹ at the airport for an individual airplane or family grouping of airplanes during the established planning period of at least five years. Based on an examination of the projected operational information for the new Angoon Airport, it has been confirmed that the 2007 Angoon Airport Master Plan’s recommended Airport Reference Code (ARC) B-II designation of the runway is appropriate for design. The facility requirements will be based on the B-II family grouping of aircraft, which includes the Aircraft Design Group (ADG) II aircraft (Grand Caravan, Otter, Beaver, and King Air 200) and Approach Category B aircraft (Navajo) that are forecast to have more than 500 annual operations.

¹ Airport Operations: The number of arrivals and departures from the airport. There are two types of operations: local and itinerant.

1. Local operations are performed by aircraft that:
 - (a) operate in the local traffic pattern or within sight of the airport;
 - (b) are known to be departing for, or arriving from, flight in local practice areas located within a 20-mile radius of the airport;
 - (c) execute simulated instrument approaches or low passes at the airport.
2. Itinerant operations are all aircraft operations other than local operations.

4.1 Design Aircraft

The aircraft forecast to operate at Angoon are similar in design characteristics and could be served by an airport designed to the standards for ADG II, Approach Category B, with a runway length of 3,300 feet for small (under 12,500 lb.) aircraft.

4.2 Wind Coverage

Wind conditions affect aircraft in varying degrees. Generally, the smaller the aircraft, the more it is affected by wind, particularly crosswinds, which are often a contributing factor in small aircraft accidents. FAA provides the following guidance on maximum crosswind components for small aircraft.

Table 2 – Allowable Crosswind Components by Aircraft Design Group

Aircraft Design Group	Allowable Crosswind Component
ADG I Cessna 185, 207, Beaver, Navajo Chieftain	10.5 knots
ADG II King Air 200, Cessna 208, Grand Caravan	13 knots

Wind coverage is the percentage of time crosswind components are below an acceptable velocity. A runway oriented to provide the greatest wind coverage with the minimum crosswind components is preferred. The desired wind coverage for an airport is 95%. A second (crosswind) runway is recommended when the primary runway orientation provides less than 95% wind coverage. Based on the wind data available for Angoon, a single runway in any orientation provides 99% or greater wind coverage at 13 knots for ADG II aircraft and 97% or greater wind coverage at 10.5 knots for ADG I aircraft.

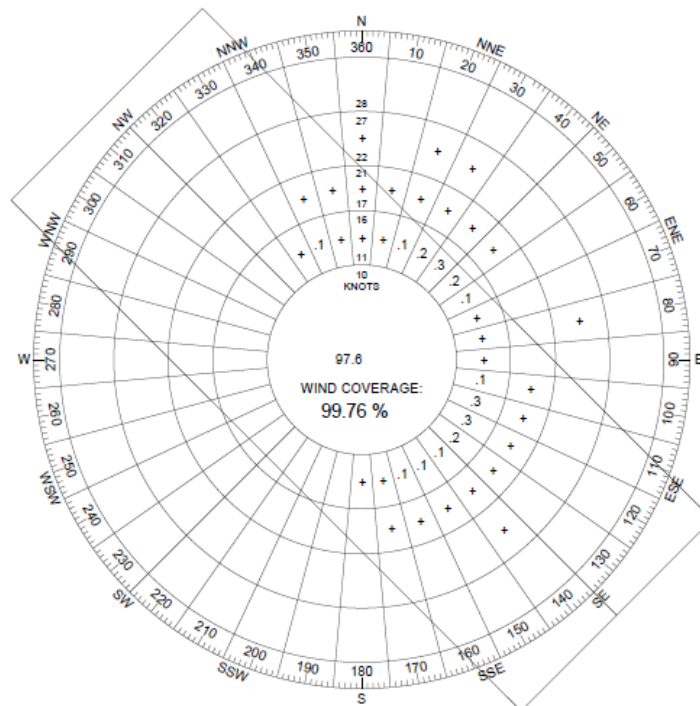

Figure 2 – Wind Coverage

Source: FAA 703830 Angoon Seaplane Base Annual Period Record 2007 to 2016

4.3 Airfield Requirements

4.3.1 Runway Length

A runway length of 3,300 feet is the minimum length recommended for a community class airport per the Alaska Aviation System Plan (AASP). A key factor for future operations will be the ultimate runway length, the operations, and the aircraft that will dictate when a longer runway will be needed. At 3,300 feet, Angoon Airport (ANG) would be one of the shortest runways in the region. For fully loaded and/or occasional operations by larger aircraft, 4,000 feet is desirable. Kake (AFE) is 4,000 feet, and it is reasonable to assume that aircraft would be routed JNU-ANG-AFE-SIT. Being able to serve multiple communities with one aircraft improves convenience for scheduling, passenger travel, and aircraft utilization as well as lowering cost. Having a similar sized runway at ANG could generally improve the operations in this region.

4.3.2 Runway Capacity

Given the number of operations and growth anticipated in Angoon, a greater growth factor in the forecast of operations would not show an increase great enough to warrant substantial changes in the facility requirements (such as a second runway or parallel taxiway). A single runway can handle between 62,000 and 131,000 operations annually based on Visual Flight Rules (VFR) conditions and calculations with taxiway at midpoint and airport open for operation 8 to 12 hours per day, 5 to 7 days per week. This is significantly more operations than projected. Parallel taxiway systems which help improve runway capacity and minimize user delays are typically not warranted until annual operations approach 20,000.

Facility requirements are listed in the table below.

Table 3 – Runway Dimensional Standards for Various Scenarios

Feature	Current Demand	Future Demand
Approach Category	B	B
ADG	II	II
Runway Length¹	3,300'	4,000' ¹
Runway Width	75'	75'
Visibility Minimums²	1 mile	1 mile
Crosswind Component	13 knots	13 knots
Runway Safety Area	150' x 3,900'	150' x 4,600'
Object Free Area	500' x 3,900'	500' x 4,600'
Runway Protection Zone³	1,000' x 500' x 700'	1,000' x 500' x 700'
Part 77 Primary Surface	500' x 3,700'	500' x 4,400'
Part 77 Approach Slope⁴	20:1 (NPI Utility)	34:1 (NPI)

1. Minimum runway length for community airports per the AASP and Alaska Aviation Preconstruction Manual is 3,300 feet. An ultimate facility runway length of 4,000 feet was selected and is consistent with the length selected in the EIS to ensure the airport could accommodate future expansion.

2. Visibility minimum of not lower than one mile was selected because the lowest visibility minimum achievable for the alternatives considered in the EIS was 1¼ miles; less-than-1-mile visibility minimums do not appear to be feasible for this site.

3. To protect areas around the airport to support beyond a 20-year horizon, it is recommended to plan for larger RPZ, as we never know what the future holds for aviation technology. Because the area is surrounded by private property, it is prudent to protect the area from development by planning beyond the 20-year horizon.

4. By definition, a non-precision instrument (NPI) approach runway means a straight-in approach is planned or has been approved (Part 77.3). Aircraft forecast to use Angoon on a regular basis are propeller-driven aircraft of 12,500 pounds or less (20:1 NPI utility). To protect areas around the airport, it is recommended to plan for lower approach slope (34:1).

4.4 Taxiway

Taxiways will be designed to meet the current standards. Since the EIS was prepared, major changes have been made to taxiway standards in the revisions to FAA Advisory Circulars (AC) 150/5300-13 and 150/5300-13A. Taxiway design requirements are no longer established solely by the airplane design group, but also depend on the wheelbase and distance between the cockpit and main gear of the design aircraft. To ensure the taxiway geometry can accommodate occasional aircraft larger than the aircraft in regular use, and to accommodate future airport expansion for larger aircraft, taxiways will be designed to meet the requirements of Taxiway Design Group (TDG) 2, allowing for main gear width of up to 20 feet and cockpit-to-main-gear distance of up to 65 feet. Current guidance indicates the taxiway intersections with runways should avoid the middle one-third of the runway length, which 401.b(5)(d) defines as a “high energy” intersection that should be avoided. “By limiting runway crossings to the outer thirds of the runway, the portion of the runway where a pilot can least maneuver to avoid a collision is kept clear.”

The key dimensional standards that need to be considered in developing the taxiways are listed in the table below.

Table 4 – Taxiway and Taxilane Design Dimensions Based on Aircraft Design Group (per AC 150/5300-13A, Table 4-1)

Feature	Facility Requirement
Design Aircraft Family	B-II, TDG 2
Runway to Aircraft Parking Area ¹	400'
Taxiway Safety Area	79'
Taxiway Object-Free Area (OFA)	131'
Taxiway Width	35'
Taxilane Centerline to Fixed or Movable Object	57.5'
Taxilane Wing Tip Clearance	18'

1. Although 250 feet is allowable, a greater offset of 400 feet is recommended to accommodate the potential for future changes in aircraft size and approach category. Making changes in the future for a greater runway offset is much more difficult once lease areas and buildings are constructed.

4.5 Navigational Aids and Airfield Lighting

If the PAPI Obstacle Clearance Surface (OCS) is clear, PAPIs will be installed on both ends of the runway. The PAPI OCS extends 4 miles out from the end of the runway.

The Automatic Surface Observation System (ASOS) located near the Angoon Seaplane Base is planned for relocation to the land-based airport to support non-precision operations. The ASOS will be sited in accordance with FAA Order 6560.28.

The FAA Remote Communication Outlet (RCO) is located on the community water tower and will be relocated to the land-based airport by FAA.

The airport will include an airfield lighting system with medium-intensity edge lighting for the taxiway and the entire runway. High-intensity lighting may provide additional lighting credit for approaches, so this will be evaluated.

Runway and taxiway markings will meet current guidance and indicate the runway is an NPI runway.

4.6 Airport Access Road

Access to the airport from the community would be via the BIA road and travel directly to the apron area, terminating in a location that provides access to lease lot owners and the general public. The topography around the proposed airport location is steep. The access road would be designed with less than maximum grades to provide a safe and reliable driving surface under all weather conditions.

As outlined in the EIS, the access road would have 9-foot lanes and 1-foot shoulders in accordance with American Association of State Highway and Transportation Officials (AASHTO) low-volume road standards. As conceptually envisioned for airport layout 12A-Echo, the road would be approximately 1,000 feet long and constructed using suitable embankment material. Existing drainage patterns would be maintained through the use of roadside ditches and cross culverts. The exact location and layout of the access road would be finalized during the design phase once the apron location, elevation, and configuration are refined.

Primary design criteria are listed in the table below.

Table 5 – Access Road Design Criteria
Based on AASHTO Guidelines for Geometric Design of Very Low-Volume Local Roads, 2001

Design Criteria	
Design Speed	25 MPH
Min. Radius of Curvature @ 6% Superelevation	115 feet
Max. Allowable Grade	11%
Stopping Sight Distance	115 feet
Minimum K Value for Crest/Sag Vertical Curves	7 / 26
Clear Zone (Where Practical)	6 feet

4.7 Other Requirements

A new apron will be constructed to accommodate lease lots, aircraft parking, and a future Snow Removal Equipment Building (SREB). The minimum apron size is 300 feet by 300 feet to accommodate lease area and general aviation (GA) aircraft. The apron will be sized in accordance with other Southcoast DOT&PF airports (such as those noted in the table below), except that the typical lease lot depth of 150 feet will be increased by 25 feet to 175 feet to accommodate the 52-foot wingspan of the Beaver.

Table 6 – Example Southcoast Airport Apron Sizes

Airport	Existing GA Apron Area	Ultimate GA Apron Area
Hoonah	165,000 sf	165,000 sf
Kake	120,000 sf	222,000 sf
Wrangell	72,000 sf	152,000 sf

A new SREB location should be planned for on the proposed apron. DOT&PF may contract with the City of Angoon to perform maintenance and operations (M&O) functions with City equipment. If this is the case, on-airport facilities may not be needed; however, a site on airport property should be reserved for future facilities.

Due to runway and airspace easement-related acquisitions, road re-platting will be required at the south end of the runway to maintain access to properties. This task will be completed during the design phase of the project.

To provide all-weather access, approaches will be developed and PAPI installed to ensure the lowest minimums can be obtained.

5 ENVIRONMENTAL REVIEW

DOT&PF is conducting the environmental review for the project. As of January 2017, the initial environmental analysis included review of available environmental documents, office and online research, a field visit, and coordination with agencies and the public.

During this phase of the Angoon Airport design, the team first met with the FAA to determine the flexibility to make adjustments to the EIS layout and alignment (Alternative 12A) to take advantage of the more detailed information obtained from review of the LIDAR mapping, numerous hand probes, and the 2017 site visit. From that initial meeting (see summary notes in Appendix B), it was understood that FAA felt there was ample flexibility on the site to accommodate the range of alignment and layout changes presented at the meeting. FAA agreed to review the EIS background data and identify any potential constraints to the alignment/layouts presented. Additionally, the EIS called for more refined wetlands work to support the permitting. DOT&PF commissioned this work in 2017 with follow-on work anticipated in the summer of 2018. Ultimately, FAA's understanding of the alternative refinement process will inform what, if any, action will be necessary to keep the project design phase reasonably consistent with the EIS.

5.1 Public Involvement

A public involvement plan was developed by HDR and approved by DOT&PF in September 2017. A copy of the plan is available as Appendix B.

A public meeting was held in Angoon on October 3, 2017, at the Angoon Community Association from 5:30-7:30 p.m. Thirty people attended the meeting. The project team (DOT&PF, PDC, and HDR) provided posters, handouts (fact sheet, FAQs, comment sheet), and business cards and gave a verbal presentation. The presentation covered the project objectives, phase in the process, location of the preferred alternative, and future steps in project development. Public meeting advertising included:

- Postcard sent to Angoon zip code (181 residents) (9/20/17)
- Email (9/20/17)
- *Juneau Empire* print ad (9/22/17)
- State of Alaska Online Public Notice (9/22/17)
- Radio
 - Sitka KCAW (9/22-10/3/17)
 - KTOO PSAs
- Facebook
 - DOT&PF Page
 - Angoon Community Association Page
 - City of Angoon Page
- Email sent to area local and elected officials



Figure 3 – 10/3/17 Public Meeting

Small-group stakeholder meetings included:

- ➔ 10/3/17 Angoon Community Association (Tribal Council)
- ➔ 10/4/17 Angoon City Council
- ➔ 10/4/17 Angoon High School Principal
- ➔ 11/20/17 Kootznoowoo Board

The project website (http://dot.alaska.gov/sereg/projects/angoon_airport_new/index.shtml) was published on December 6, 2017.

Key issues raised during the public outreach to date include:

- ➔ Local hire during construction
- ➔ Access to the beach south of the airport site
- ➔ Concern about potential contamination to the water source east of the airport site
- ➔ Questions about maintenance
- ➔ Tree clearing, interest in using the lumber and doing the clearing
- ➔ Improvements to the existing BIA access road

6 LAND STATUS

Landowners that could potentially be affected by the project include Kootznoowoo, Inc., the City of Angoon, the State of Alaska, and a number of individual private landowners in the subdivided land. Lands that make up the Monument–Wilderness Area outside the project area are public lands managed by the U.S. Forest Service. Additionally, under the Alaska National Interest Lands Conservation Act (ANILCA) Kootznoowoo, Inc. was granted the surface rights for shoreline lands adjacent to the Monument–Wilderness Area. Subsurface rights within the project area are held by Sealaska.

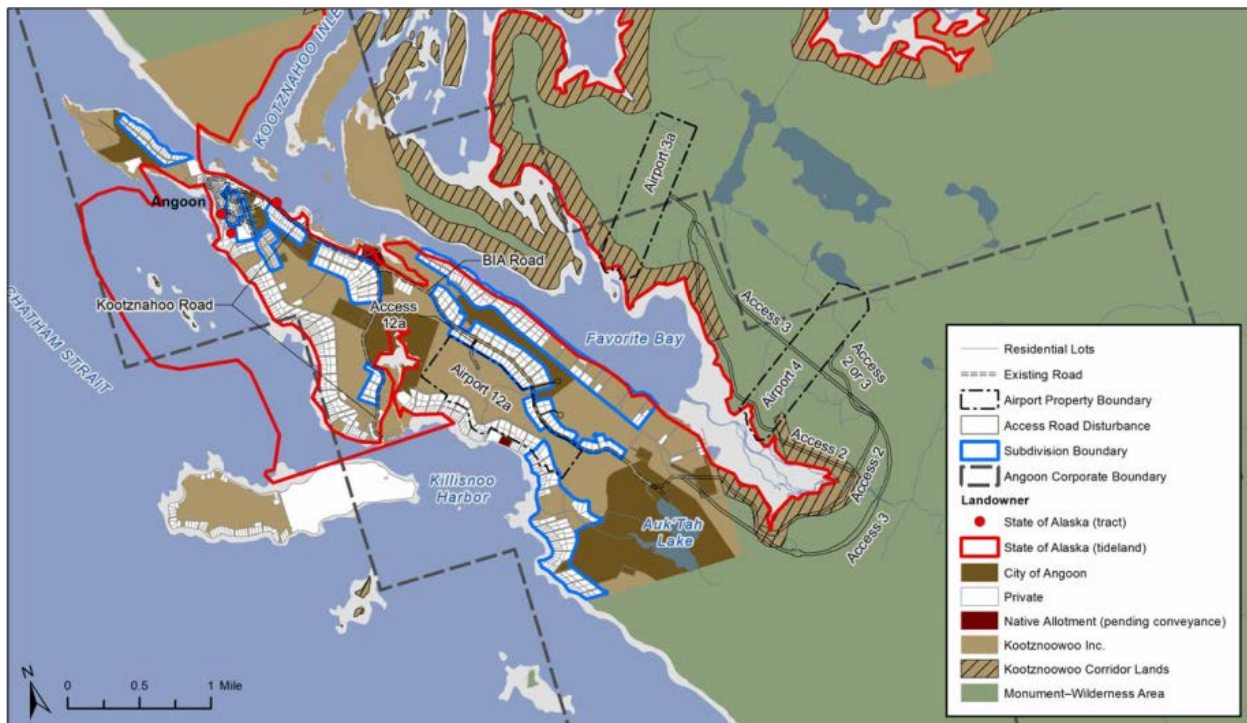

Figure 4 – General Land Ownership from EIS

7 ALTERNATIVES

The alternative development and analysis process was iterative, beginning with desktop information and consideration of the EIS design parameters, then being refined as more data was obtained. This section describes the process and analysis, which resulted in recommendation of Alternative 12A-Echo.

7.1 Initial Development

Development of an airport layout requires an understanding of existing conditions and considerations that could impact the reasonableness of any alternatives. Information gained from site visits, data collection, public involvement, and coordination with airport stakeholders, combined with the facility requirements, influenced the identification and development of additional concepts and selection of a final alternative for the Angoon airport. As part of this effort, a technical memorandum was developed for the initial concept layouts as well as a location study to determine the best alternative(s) to be carried forward. The full technical memorandum is included as Appendix C.

7.1.1 Design Criteria

The design criteria for the new not-lower-than-1-mile-visibility-minimums airport are based on the aircraft forecast to fly into Angoon after the airport is constructed and the guidance in FAA AC 150/5300-13A – Airport Design. The design aircraft is a small or utility airplane (under 12,500 lbs.), ADG II, Aircraft Approach Category B. A visibility minimum of not lower than one mile was used to select the design criteria for the concept development. Provision will be made to ensure the airport can accommodate future expansion. The forecast and design criteria are documented in the technical memo “Forecast of Aviation Activity & Facility Requirements” (December 2017).

For development and evaluation of initial concepts, only the primary elements of the airport facilities were considered. Key dimensional standards used in the initial evaluation are tabled below.

Table 7 – Key Dimensional Standards

Dimension	Size	Dimension	Size
Runway Length	3,300' (4,000' ultimate)	Taxiway Safety Area Width	79' minimum
Runway Width	75'	Apron and Aviation Support Area ¹	475' x 500'
Runway Safety Area Width	150'	Apron Offset from Runway Centerline	400' desired 250' minimum
Runway Safety Area Length beyond Runway End	300'	Maximum Apron Grade	2% maximum
Profile Grade	2% maximum		

1. The apron for the project will be sized to accommodate expected demand.

7.1.2 Initial Concepts

An EIS was prepared for evaluation of various airport alternatives, and the FAA ROD documents the selection of Alternative 12A as the environmentally preferred alternative. This location is approximately two miles southeast of the community, with a runway oriented northwest-to-southeast located west of an existing road to the water reservoir (BIA Road).

DOT&PF provided the following information and resources at the start of the project:

- LIDAR-based mapping (2-foot contours)
- Orthophotography
- Geotechnical exploration maps of probe and test pit locations and initial findings

Other background information was found in the EIS and its appendices.

A pre-design kickoff meeting was held in September 2017 with the FAA, DOT&PF, and PDC to get an understanding of the design basis of the FAA's preferred alternative and of the flexibility of the design within the selected site. Concepts that rotated the runway alignment and moved the apron location were discussed, and the FAA indicated there was a lot of flexibility within the site to allow these adjustments to the alignment and apron locations. Studies prepared for the EIS determined that precision instrument approaches were not feasible in Angoon. FAA confirmed that the airport should be designed for NPI approaches and utility aircraft, and to plan for an initial runway of 3,300 feet and ultimate runway length of 4,000 feet.

PDC prepared four initial concepts—Alpha (Alternative 12A from EIS), Bravo, Charlie, and Delta—to compare the advantages and disadvantages of different runway alignments and apron locations. A field reconnaissance was conducted on October 4–5, 2017. Based largely on the results of hydrology and geotechnical probe and test work done during the field reconnaissance, a fifth concept, Echo, was added.

7.1.3 Initial Concept Analysis

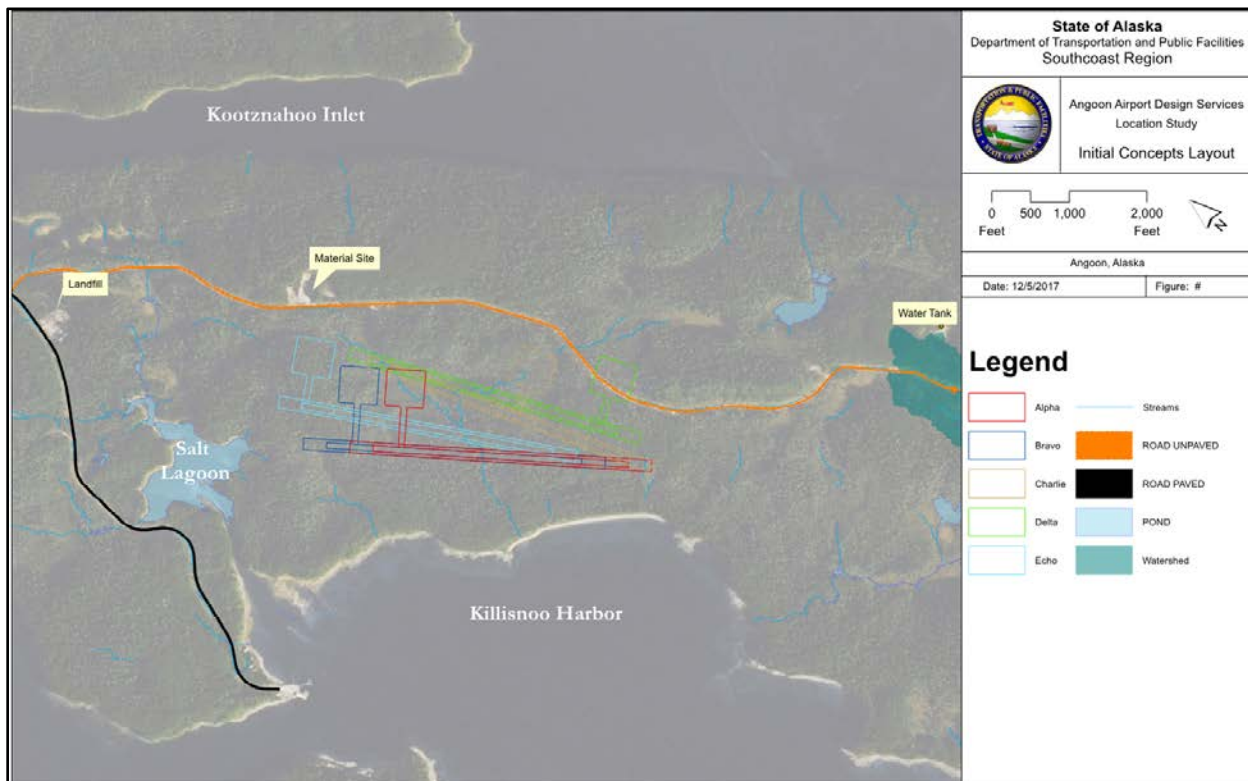

Figure 5 – Concept Layouts

All of the concepts are located in the same general area, approximately two miles southeast of the community, with a runway-oriented northwest-to-southeast placed west of an existing road to the water reservoir (BIA Road).

The area is undeveloped, rolling terrain generally sloping to the southwest. Very large trees are found on the higher ground, and dense brush covers the lower, saturated ground. Several streams cross the area. As part of analyzing each concept, a hydrology review was performed. A copy of the review and comments on each concept are included in Appendix D. All the concepts avoid Native allotment properties southwest of the runway, which would require a lengthy, difficult process to acquire for airport use.

The Bravo concept showed a slight improvement over Alpha due to apron location and earthwork volumes, but this concept was still poorly located relative to drainage, soils, and topography, not an appreciable improvement over Alpha. It was decided to drop Bravo and carry forward the EIS preferred Alpha concept for further comparative analysis. Revisions that would improve the Alpha concept if Alpha shows advantages over the other concepts advancing include changing the apron location. Otherwise, it is planned to retain Alpha for purposes of comparing other concepts to analyze the environmental impacts.

The Delta concept did not provide a benefit over the similarly aligned Charlie concept, and the added cost and effort to relocate the road, electrical lines, and water lines serving the community helped to eliminate this concept from further consideration.

It was recommended that three concepts move forward: Alpha, Charlie, and Echo. As we moved forward with the more detailed evaluation process, the refined concepts were called alternatives. Refinements to the alternatives were made as additional information became available.

Evaluation criteria used to assess the advantages and disadvantages of the three remaining airport alternatives were developed and divided into three categories: safety, environmental impacts, and quality design.

An evaluation matrix was prepared to weight the elements of each category, score the alternatives for each criterion, and compute the weighted scores for each alternative. The alternatives evaluation criteria and scoring matrix are included in Appendix C. Through the process it became apparent that scoring was not needed. Ranking each of the alternatives and the relative importance in comparison to each other made it apparent which alternative was the best.

7.2 Alternative Refinement and Evaluation Process

As a result of the considerations discussed above, and in coordination with DOT&PF, it was determined that only the three alternatives Alpha, Charlie, and Echo were viable alternatives to be carried forward for further evaluation. (See Figure 6 below for general layouts of all three viable alternatives and Appendix E for detailed layouts and cross sections of each alternative.) The more detailed development of these alternatives was an iterative process and included an analysis that focused on evaluating the three alternatives for Safety, Environmental Impacts, and Quality design.

Another critical element to determining which alternative would be carried forward was an initial approach analysis to determine if any fatal flaws existed that would preclude an approach procedure development or installation of a PAPI. This primarily focused on the south approach, as it appeared to be the more restrictive approach due to trees and terrain. A summary figure is provided below.



Figure 6 – Alternatives A, C, E Layout

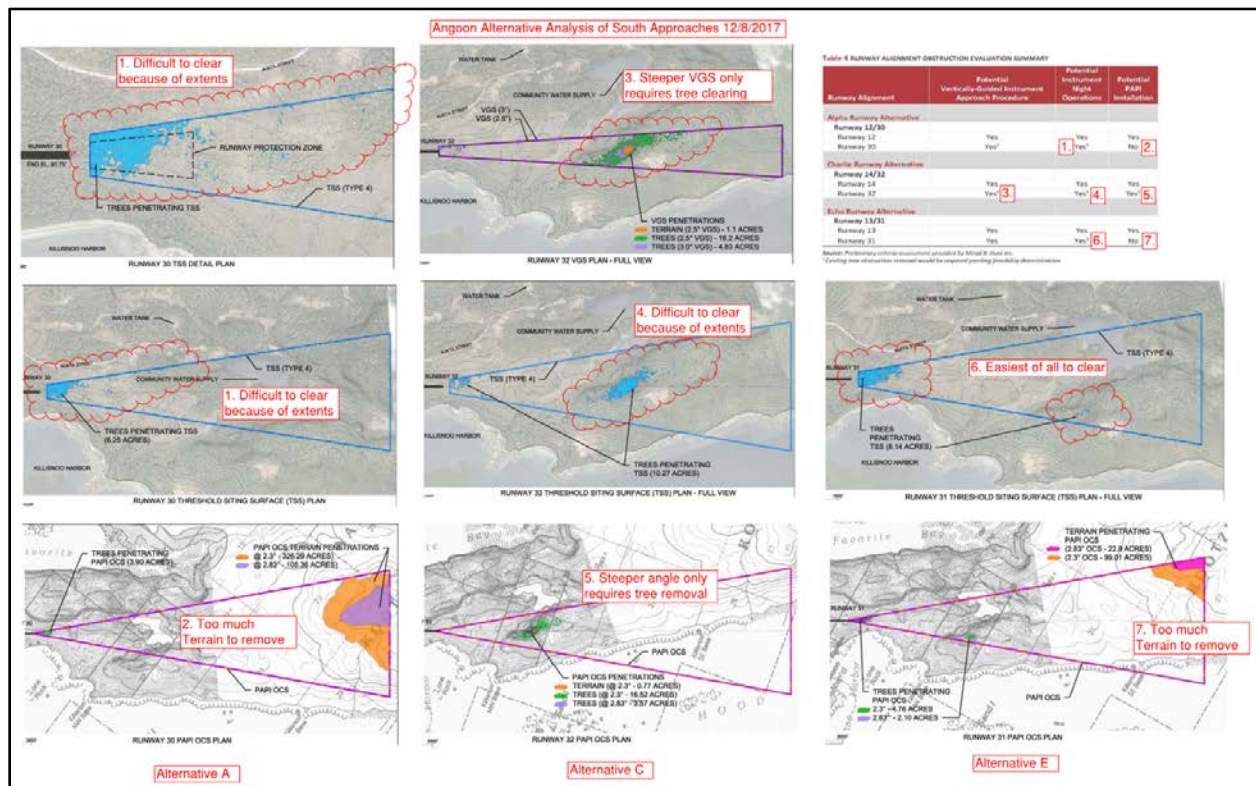

Figure 7 – Approach Analysis of South End (full-size version included in Appendix E)

7.2.1 Dropping of Alternative 12A-Alpha

Alternative Alpha was developed to closely match the information that could be gleaned from the EIS and supporting studies for the FAA preferred alternative. Upon review of the alternative and subsequent consultation with DOT&PF, this alternative was dropped from further consideration for the following reasons:

- Of the three alternatives, this has the highest cut/fill quantities—nearly three times that of Echo—which results in a much higher construction cost.
- The deep fills in the middle of the embankment could result in differential settlement and create the highest long-term M&O cost for maintaining the facility.
- The PAPI OCS can be cleared of tree penetrations on the north end, but the south end has terrain penetrations 4 miles out that are not practical to remove. There is also likely no opportunity for an approach on the south end due to multiple and significant terrain and tree penetrations to other surfaces.
- Approaches on the north end are directly over a high school, churches, and a medical clinic (public gathering places), which is discouraged by FAA.
- Tree removal on the north end near the Salt Lagoon eliminates the buffer zone for storm water management.
- The south approach is directly over the community's water supply.
- Future runway extension would be in deep fill on soft soils, with potential to cost the most and create differential settlement issues.

7.2.2 Dropping of Alternative 12A-Charlie

The Charlie concept was prepared as an attempt to obtain clear PAPI obstacle clearance surfaces on both ends of the runway. Upon review of the alternative and subsequent consultation with DOT&PF, this alternative was dropped from further consideration for the following reasons:

- Alternative 12A-Charlie is in the worst soils, with the greatest potential for problems during construction and for increased maintenance requirements once the project is complete. In particular, it is in the deepest peat, which makes for extremely difficult construction and stormwater management.
- It requires two runway culverts, both in poor foundation soils, leading to potential long-term settlement issues.
- It is the only alternative with a taxiway culvert, which will add M&O costs.
- Creek crossings are on a peat surface, increasing the likelihood of construction problems as compared to other alternatives.
- While fill costs would be lower initially, this alternative has the highest construction risk because of potential soil difficulties.
- Fill beneath the apron is very deep.
- This alternative would require acquisition from more properties than the others, and maintaining access from remaining private properties to the coastline would be more difficult.

7.2.3 Alternative 12A-Echo

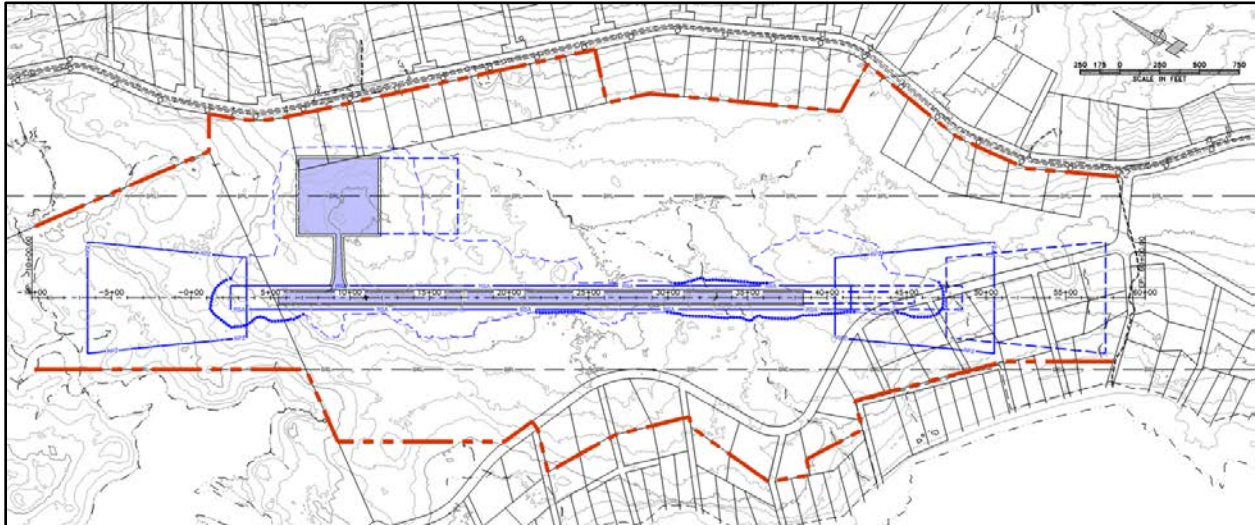

Figure 8 – Alternative 12A-Echo

The design team prepared the Echo concept following a site visit in October 2017. This option would place a greater part of the runway on better soils and avoid streams where possible. Upon review of the alternative and subsequent consultation with DOT&PF, this alternative was carried forward for further consideration due to the following reasons:

- ➔ Alternative 12A-Echo involves the smallest quantity of peat, which is better for disposal, stormwater management, lower initial construction cost, as well as a smaller footprint of wetlands impacts with associated decrease in mitigation costs.
- ➔ The lowest total quantity of fill will be needed, reducing potential construction costs.
- ➔ Only a single stream crossing will pass under the runway, and no taxiway culvert is required.
- ➔ This alternative is both the closest to a potential material site (the Knob) and the one with the most stable subsurface (requiring the least ground improvement).
- ➔ The location in better soils, on an alignment requiring less fill than other alternatives, results in the lowest construction risk and the lowest potential M&O cost.
- ➔ Potential improved approaches on Runway 30 end could be achieved with the least off-airport tree clearing.
- ➔ The layout supports extension of the runway either during initial construction or in the future. Likewise, the apron is sited for future expansion with minimal work. Of the three alternatives, Echo would require the smallest quantity of material for future expansion.
- ➔ Alternative 12A-Echo would have the least impact to private property.
- ➔ Access to the coastline and to remaining properties is the best.

7.3 Alternative 12A-Echo to be Carried Forward

To this point, alternative development and evaluations have included coordination with DOT&PF, FAA, and the public, as well as detailed engineering evaluations and an environmental overview. The environmental overview was based on information presented in the EIS, with updates of more recent information that was readily available. Both Alternatives 12A-Alpha and 12A-Charlie appear viable, although both have a number of potential impacts that rank them less desirable than Echo.

The recommended next step is to continue development of Alternative 12A-Echo by performing the Phase 3 geotechnical investigation, advancing the engineering to 35% design level, and developing

the hydrologic/hydraulic (H&H) design. These tasks are all needed to support the environmental analysis and permitting phase.

An item essential to begin considering at an early stage is the airport ROW requirements. The proposed draft ROW boundary is shown below. Several factors affect the location of the boundary, including the area needed for construction of physical features as well as protection of imaginary surfaces such as approaches and transitional surfaces relative to the terrain and tree heights. (See Appendix E for illustration of terrain plus tree heights with transitional surfaces overlain; this graphic was the basis of the preliminary ROW boundary.) This boundary may change slightly as design progresses. Please note that the property boundaries on each end have not yet been defined; an approach study is in progress to further define ROW requirements beyond the RPZ to allow for removal of obstructions.



Figure 9 – Initial Draft of Proposed ROW Boundary

8 GEOTECHNICAL

A geotechnical considerations memorandum was prepared and provided to DOT&PF; it is included as Appendix F to this report. Below are some general findings. PDC has conducted two site visits to date. The first consisted of an overview of the project site and four concept alignments on site 12A (Alpha, Bravo, Charlie, and Delta), familiarization with the materials encountered during recent subsurface exploration activities conducted by DOT&PF, and identification of potential material sources. As a result of the first site visit, a fifth concept alignment (Echo) was developed. During the second site visit, Cody Kreitel, PE, of PDC helped the DOT&PF geologist collect hand probe data to provide additional data for the three runway alignments.

8.1 Subsurface Materials

Four general geologic materials have been identified: surficial organics, glacial outwash (which consisted of varying amounts of silts, sands, and gravels), glacial till (generally fine grained and over consolidated), and bedrock. The glacial outwash and glacial till materials are discontinuous across the site. Along the three alignments being considered, surficial organics range in depth from very thin (6 inches or less) to over 10 feet thick.

8.2 Geologic Hazards

Three primary geotechnical hazards have been identified:

- Long-term settlement of runway embankment soils
- Downhill creep of soft native soils under embankment loading
- Erosion of embankment materials from streams and/or drainage ditches

Both long-term settlement and downhill creep can generally be mitigated by excavating the native soils to the bedrock and/or glacial till prior to embankment fill placement. Erosion of the embankment materials may be mitigated through proper ditching, erosion control in the form of rock lining or matting, vegetation, and/or the use of large-diameter fill material in the bottom portion of the embankment.

8.3 Material Sites

Three potential alternatives for material borrow sites have been identified near the project site:

- A high area near the north end of the project site, which has been referred to as the “Knob,” is on the project site and requires the shortest haul route.
- An existing borrow pit owned by Sealaska is located near the north end of the project site on the northeast side of the BIA road. Land ownership in this area may complicate access and availability.
- Along the BIA road between the Sealaska borrow pit and the City of Angoon Water Treatment facility, several high ridge areas with rock outcroppings visible on the uphill side of the BIA road were identified. These areas are approximately 1.5 miles southeast of the existing Sealaska borrow pit and would require a farther haul distance than the Knob or the Sealaska pit. Land ownership in this area may need to be researched to evaluate access and availability.

9 HYDROLOGIC AND HYDRAULIC ANALYSIS

As part of the concept and alternative development, a site visit was conducted to observe the hydrologic and hydraulic (H&H) conditions at the site. After the site visit, a review was performed to provide comments on each of the concepts and identify any fatal flaws from an H&H perspective. The complete analysis is provided as Appendix D. Below are some key discussion elements from the analysis.

9.1 Alternative 12A-Alpha

Alternative 12A-Alpha crosses the creek in a good location, outside of the two creek forks. It will require a single 300-foot-long culvert for the creek. There appears to be sufficient fill depth to install the required culvert, which is estimated to be a 6-foot-high by 6- to 10-foot-wide concrete box culvert.

The position of the culvert under the runway, downstream of the confluence of the two forks, maintains the two forks and their function of capturing and channeling the bog discharge. This function is very important in controlling groundwater flow and would be extremely difficult to replicate through ditch construction.

The south end of Alternative 12A-Alpha ends at a large ravine, STA 46+50, and fills the ravine. This ravine is a natural drainage path. If the runway were moved north, the ravine would be left unfilled and the drainage from the east side of the runway could be directed to the ravine and flow away from the site.

The apron is located in the bog on top of the north creek fork. With the apron located here, the creek must be rerouted in a ditch about 500 to 600 feet long. Because there is deep peat in the bog and the creek channel bottom is peat, construction of a stable channel will require excavating the peat from under the channel location, backfilling the location, and rebuilding the creek in the fill, all of which increase cost and wetland impacts.

9.2 Alternative 12A-Charlie

Alternative 12A-Charlie twists the north end of the runway east. Moving the runway in this direction places it over long segments of the north and south creek channel and in the bog. Constructing the runway here will require extensive construction of new creek channels. Because there is deep peat in the bog, construction of a stable channel will require excavating the peat from under the channel location, backfilling the location, and rebuilding the creek in the fill. This increases cost and wetland impacts and represents the least desirable location for the runway in regard to creek impacts.

The apron is located on the west side of the north end of the runway. This location requires cutting the north side of the apron into a hill and placing the west side on a fill pad. The configuration of the apron and taxiway will create an area where drainage can collect and require a culvert under the taxiway.

9.3 Alternative 12A-Echo

The Alternative 12A-Echo runway sits atop the high ground west of the two creek forks and the associated bog, crossing the main creek channel downstream of the forks' confluence. This crossing will require a slightly longer culvert, approximately 350 feet, because of the greater skew crossing angle. However, this is the ideal location, as it maintains the two forks and their function of capturing and channeling the bog discharge. This function is important in controlling groundwater flow and would be extremely difficult to replicate through ditch construction.

Alternative 12A-Echo will also place fill in the bog at the north end of the runway. The fill may impact bog drainage patterns, which may reroute drainage into the salt chuck. The increased water flow, especially if it contains sediment, could degrade the water quality of the Salt Lagoon habitat and should be evaluated. If it is not possible to reroute the drainage north of the runway and west of the apron to the north, a second, smaller culvert will need to be placed under the runway adjacent to the apron. Ideally this second culvert would be placed directly on the northeast corner where the runway meets the apron, bedded on competent material, and would allow runoff from the north and east sides of the runway and the apron to discharge through the runway into the vegetation on the south side of the runway.

The apron will be placed over the Knob at the north end of the runway. Drainage off the apron area can be addressed by constructing the apron and quarry area to discharge to the surrounding vegetation at multiple points and dispersing the drainage into the natural vegetation, minimizing potential impacts. This also allows for construction of the access road to the apron at the divide between the Salt Lagoon and South Creek fork drainage basins, minimizing impacts to both basins and reducing the need for drainage structures.

9.4 Groundwater

Due to saturated organics, excavation will be difficult in the low-lying, wet boggy areas. Dewatering will likely be required during excavation in these areas. Because of the saturated organic soils, a viable dewatering alternative may consist of ditching around the perimeter of the excavations and directing the water to low-lying areas and/or sump pump locations as appropriate. Any ditching in the saturated organics will require very flat cut slopes to be stable. Alternative 12A-Charlie presents the greatest challenge for excavation of saturated organic materials in terms of total quantity, followed by Alpha, and finally Echo.

10 CONCEPT-LEVEL COST

A cost estimate was developed to determine the preliminary probable cost for airport development and land acquisition for Alternative 12A-Echo.

The estimated construction cost for development of a land-based airport at Angoon is \$42M; ROW acquisition is estimated to be \$18M, and environmental permitting and mitigation is estimated to cost \$8M.

Total project cost is estimated at \$68M. Details of the conceptual cost estimate are included in Appendix G.

11 DATA GAPS AND ANALYSIS

Initial tree clearing needs have been identified using LIDAR data. This initial analysis was completed to help define the ROW limits (above). Additional analysis will be required to detail the tree clearing needed for construction, approaches, and other FAA Part 77 surfaces. One aspect of the property issue is dealing with all the timber that will become available after the clearing. Further investigation is needed to determine who will own the timber and whether the timber can be given to residents of the community or if it will become the property of the State and/or the contractor to dispose of.

Additional geotechnical information is required. Substantial amounts of poor foundation soils and waste materials are expected to be generated as part of the project. For long-term embankment stability, foundation soil strengths and type need to be identified by additional drilling and exploration. The waste material that is likely to be generated will be a saturated organic material that will need to have a stable disposal location identified that does not impact future development plans.

Environmental coordination with FAA to get clear understanding of their environmental process and information needed to complete a consistency determination for the Echo Alternative. Once that information is identified steps can be taken to gather any additional information and prepare any additional environmental documents.



APPENDIX A

FORECAST AND FACILITY REQUIREMENTS INFORMATION

TECHNICAL MEMORANDUM

For:	David Pyeatt, Aviation Project Manager Alaska Department of Transportation and Public Facilities	Date	November 2017
Client #/PDC #	SFAPT00086/17171JN	Prepared by	Patrick Cotter, AICP Alex London Angela Smith, PE Ken Risse, PE Brian Hanson, PE
Project Name	Angoon Airport Design Services	Reviewed by	Royce Conlon, PE
Subject	<i>Forecast of Aviation Activity</i>		

This technical memorandum presents the aviation demand forecast and facility requirements for the proposed Angoon Airport. Demand forecasts, reconnaissance studies, and feasibility reviews have been completed for Angoon going back to 1983. Angoon’s Airport Master Plan was completed in May 2007 with the prospect of beginning construction by 2010. The Environmental Impact Study (EIS) process was initiated in 2008, and the final report was published in September 2016. The preferred site alternative identified in the Master Plan, Site 3, was superseded by Site 12a during preparation of the EIS.

The purpose, need, and feasibility for the project are well established. The forecast provides the basis for aviation demand and identifies the design aircraft.

Forecast of Aviation Activity

Forecasts of future levels of aviation activity are the basis for making decisions in airport planning and development. A comprehensive forecast includes elements of socioeconomics, demographics, geography, and external factors. Angoon Airport’s purpose and need is functionally based on a latent demand for more reliable air travel, which the current seaplane base could not provide regardless of expansion. It is expected that the land-based airport services will supplement rather than supplant the sea-based airport services.

The methodology used in this forecast is based on the process recommended in FAA Advisory Circular (AC) 150/5070-6B, *Airport Master Plans*, and in the supplemental FAA publication, *Forecasting Aviation Activity by Airport*. These documents provide national guidance for the development of airport master plans and have been used since enactment of the Airport and Air/Ways Development Act of 1970.

Recommended steps include:

- Step 1 – Identify aviation activity measures
- Step 2 – Review previous airport forecasts
- Step 3 – Gather data
- Step 4 – Select forecast methods
- Step 5 – Apply forecast methods and evaluate results
- Step 6 – Compare forecast with Terminal Area Forecast (TAF)

**Step 1 –
 Identify Aviation
 Activity
 Parameters and
 Measures to
 Forecast**

The level and type of aviation activity anticipated at an airport, as well as the nature of the planning to be done, determine the factors to be forecast. Generally, the most important activities for airfield planning are **aircraft operations** and the **fleet mix**, since these define the runway and taxiway requirements. Plans for general aviation (GA) airports require forecasts of aircraft operations and based aircraft to define runway, taxiway, and aircraft parking requirements.

Practical considerations dictate the level of detail and effort that should go into an airport planning forecast. Current air traffic at Angoon consists of scheduled passenger service, charter service, and mail and freight (though most of this is done via marine service). The aircraft fleet mix consists of a number of floatplanes with passenger capacity ranging from 3 to 10. Air carriers currently serving Angoon Seaplane Base stated that they will provide wheel plane service at the prospective Angoon Airport using a Cessna Grand Caravan (9 passengers), an instrument-capable Piper Navajo Twin (8 passengers), and amphibious planes as necessary.

**Step 2 –
 Collect and Review
 Previous Airport
 Forecasts**

Relevant forecasts of aviation activity at Angoon are summarized below.

**Angoon Airport
 Reconnaissance
 Study (2004)**

Although planning activities for the Angoon Airport began in the 1980s, the first airport demand forecast was created in 2000 for the Angoon Airport Reconnaissance Study, April 2004.

In 2007, the DOT&PF published the Angoon Airport Master Plan. This publication forecasted aircraft operations and passenger enplanements as summarized in the following table. An annual growth rate of 1.2% was used to forecast future operations, enplanements, and cargo.

Table 1 - 2004 Angoon Airport Reconnaissance Study, Air Traffic Forecast - 1999 to 2026

	1999 (Base)	Est. Opening Year 2007	2011	2016	2026
Enplanements	4,000	4,610	4,960	5,420	6,480
Air Cargo (total pounds)	116,643	126,880	132,340	139,490	154,970
Annual Operations					
Air Carrier	3,700	3,700	3,700	3,700	3,700
Air Cargo	500	500	500	500	500
Emergency Medical	100	100	100	100	100
General Aviation	500	500	500	550	600
Total Annual Operations	4,800	4,800	4,800	4,850	4,900

**FAA Terminal Area
 Forecast (TAF)**

The most recently published FAA TAF provides projections for key elements of aviation activity from 2003 through 2020. The TAF is provided for individual airports listed in the National Plan of Integrated Airport Systems (NPIAS) based on a variety of factors, including historical airport market share as well as the FAA national aviation forecast model. The TAFs are unconstrained; i.e., the forecasts assume the airport and air traffic system can accommodate whatever level of demand may be placed upon them. Existing FAA TAF for Angoon extends through 2045.

Table 2 – FAA Terminal Area Forecast for Angoon Seaplane Base, 2015-2045

Year	Scheduled Enplanements			Itinerant Operations				
	Air Carrier	Commuter	Total	Air Carrier	Air Taxi & Commuter	GA	Mil	Total
2015	-	1,772	1,772	-	1,000	150	-	1,150
2020	-	1,998	1,998	-	1,000	150	-	1,150
2025	-	2,053	2,053	-	1,000	150	-	1,150
2030	-	2,108	2,108	-	1,000	150	-	1,150
2035	-	2,163	2,163	-	1,000	150	-	1,150
2040	-	2,219	2,219	-	1,000	150	-	1,150
2045	-	2,279	2,279	-	1,000	150	-	1,150

Angoon Airport Master Plan (2007)

As part of the Angoon Airport Master Plan (2007), low, moderate, and high rates of growth for air traffic at Angoon were estimated using trend line analysis, with some adjustments for possible one-time events with large impacts on traffic at the facility. The analysis was developed from examination of prior forecasts, historic growth trends in past air traffic, population, the economy, and other factors impacting air transportation demand.

This forecast uses growth rates of 0%, 0.5%, and 1.5% for low, moderate, and high growth scenarios respectively.

Table 3 – Angoon Airport Forecast Summary 2004 to 2029

Scenario	2004 (Base)	Opening 2009	2014	2019	2024	2029
Aircraft Operations						
Low Forecast (0%)	5,008	3,407	3,407	3,407	3,407	3,407
Moderate Forecast (0.5%)	5,008	3,589	3,680	3,773	3,868	3,966
High Forecast (1.5%)	5,008	3,860	2,884	3,107	3,347	3,605
Enplanements (includes Charters)						
Low Forecast (0%)	3,896	4,096	4,096	4,096	4,096	4,096
Moderate Forecast (0.5%)	3,896	4,344	4,454	4,567	4,682	4,800
High Forecast (1.5%)	3,896	4,697	5,410	5,828	6,279	6,764
Cargo/Mail (enplaned & deplaned – in pounds)						
Low Forecast (0%)	368,137	368,137	368,137	368,137	368,137	368,137
Moderate Forecast (0.5%)	368,137	412,433	422,847	433,525	444,472	455,695
High Forecast (1.5%)	368,137	446,588	501,102	539,829	581,550	626,494
Based Aircraft						
Low Forecast (0%)	0	2	2	2	2	2
Moderate Forecast (0.5%)	0	3	3	3	3	3
High Forecast (1.5%)	0	4	4	4	4	5

Step 3 – Gather Data

The FAA requires master plan forecasts to incorporate the number of aircraft operations for various categories of aircraft. Passenger enplanement, cargo, mail, and freight data are also recommended, and the governing AC specifies that population, employment rates, and socio-economic factors be included, as any of these can also affect the forecast.

Air traffic operations at Angoon Seaplane Base are collected from FAA’s Airport Master Record Form 5010, the FAA TAF, the NPIAS, the U.S. Department of Transportation (USDOT) Bureau of Transportation Statistics T-100 database, and the Alaska Aviation System Plan (AASP).

Data also came from interviews with airport users, potential airport users, medevac providers, and Angoon-based industry.

Passengers Passenger traffic at Angoon is strong. The USDOT T-100 database shows a range of 3,100-4,100 passengers per year since 2012.

Table 4 - Historic Angoon Seaplane Base Passenger Enplanements, 2012-2016

Year	2012	2013	2014	2015	2016
Passengers	3,195	3,222	3,104	3,350	4,095

Freight and Mail The USDOT T-100 data shows a history of freight or mail that approximately tracks changes in passenger enplanements during the same period.

Table 5 - Historic Angoon Seaplane Base Freight and Mail, 2012-2016

Year	2012	2013	2014	2015	2016
Freight & Mail (Lbs.)	62,363	72,457	70,383	79,449	114,762

Based Aircraft According to the FAA Airport Master Record Form 5010, there are no based aircraft at Angoon Seaplane Base. Previous forecasting efforts and interviews with airport users, however, revealed a number of operators and fleet mix (more below).

Aircraft Operations There are two primary sources of aircraft operations for Angoon Seaplane Base: the FAA’s Form 5010, *Airport Master Record*, and the FAA Terminal Area Forecast. These data are presented in the table below.

Table 6 - AGN Aircraft Operations 2016

Source	Air Carrier	Air Taxi	GA Local	GA Itinerant	Military
Form 5010	0	1,700	0	0	0
TAF	0	1,000	0	150	0

Ferry Service Angoon residents can also use the Alaska Marine Highway System (AMHS) to travel outside the community. The AMHS serves Angoon year-round with a ferry connection to Juneau. Embarking passenger data for Angoon are below. These data are presented to illustrate the potential for additional passenger enplanements should air travel costs be reduced and reliability improved. Traveling from Angoon to Juneau is much faster via airplane than the ferry (40 minutes one-way vs. 7.5 hours one-way). The current (October 2017) ferry fare is \$102.00 round-trip Angoon to Juneau. A round-trip airfare AGN to JNU is \$288.00 (October 2017).

Table 7 - Historic AMHS Embarking Passengers at Angoon

2011	2012	2013	2014	2015
4,172	4,028	3,865	3,982	4,112

Fleet Mix The Angoon Seaplane Base is currently served by Cessna 208 Caravan, Cessna 206, DeHavilland Otter, and DeHavilland Beaver aircraft. These are equipped with floats or amphibious landing gear.

Table 8 lists the types and Aircraft Design Group (ADG) of aircraft that operate in the sub-region and serve communities such as Kake and Hoonah.

Table 8 - Current (2017) Fleet Mix Serving Southeast Alaska Communities

Operator	Aircraft	ADG	Use
Alaska Seaplanes¹	Cessna 208B Grand Caravan (wheels)	II	Air Taxi
Alaska Seaplanes	Piper Navajo Chieftain (wheels)	I	Air Taxi
Alaska Seaplanes	Cessna 207 (wheels)	I	Air Taxi
Wings Airways	DeHavilland Otter	II	Air Taxi
Ward Air	DeHavilland Otter (amphib/floats)	II	Air Taxi
Ward Air	DeHavilland Beaver (floats/skis/amphib)	I	Air Taxi
Ward Air	Cessna 310 (wheels)	I	Air Taxi
Ward Air	Cessna 185 (floats)	I	Air Taxi
Island Air Express	Cessna Grand Caravan	II	Freight
Harris Air	Piper Navajo Chieftain (wheels)	I	Air Taxi
Guardian Flight	King Air 200	II	Medevac
Guardian Flight	King Air 350	II	Medevac
Guardian Flight	Learjet 35A	I	Medevac
Guardian Flight	Hawker (Beechjet) 400	I	Medevac
Guardian Flight	Cessna 208 Caravan	II	Medevac
LifeMed Alaska	Learjet	I	Medevac
LifeMed Alaska	King Air 200	II	Medevac

¹Alaska Seaplanes currently operates 99% of the air taxi operations occurring at Angoon Seaplane Base.

**Step 4 –
 Select Forecast
 Methods**

While there are several acceptable techniques and procedures for forecasting aviation activity at a specific airport, most forecasts utilize basic statistical techniques such as linear regression, exponential smoothing, or share analysis. To determine which method is most appropriate, it is important to look at factors that will affect aviation demand. The following discussion is an overview of the factors affecting aviation demand at the new Angoon Airport and the forecast method applied.

Economic Activity An analysis of socioeconomic activity is usually helpful in developing a forecast of aviation demand. Projected increases in population or economic activity can lead to increased use of an airport.

The following section highlights major factors of socioeconomic change in Angoon. These include:

- Population forecasts
- Tourism
- Commercial Fishing & Seafood Processing Infrastructure

Population

The population of Angoon declined from 1993 to 2009 and has stabilized between 430 and 460 people since 2009. The compound annual growth rate between 2000 and 2016 is -1.52%. According to the Alaska Department of Labor and Workforce Development’s projected growth for the Hoonah-Angoon Census Area, population decline is forecasted to steady at a -0.29% compound annual growth rate between 2015 and 2030.

Angoon community leaders believe, however, that recent efforts to create jobs in Angoon through tourism, as well as the addition of reliable air transportation, may be the stimulus needed to reverse the population decline.

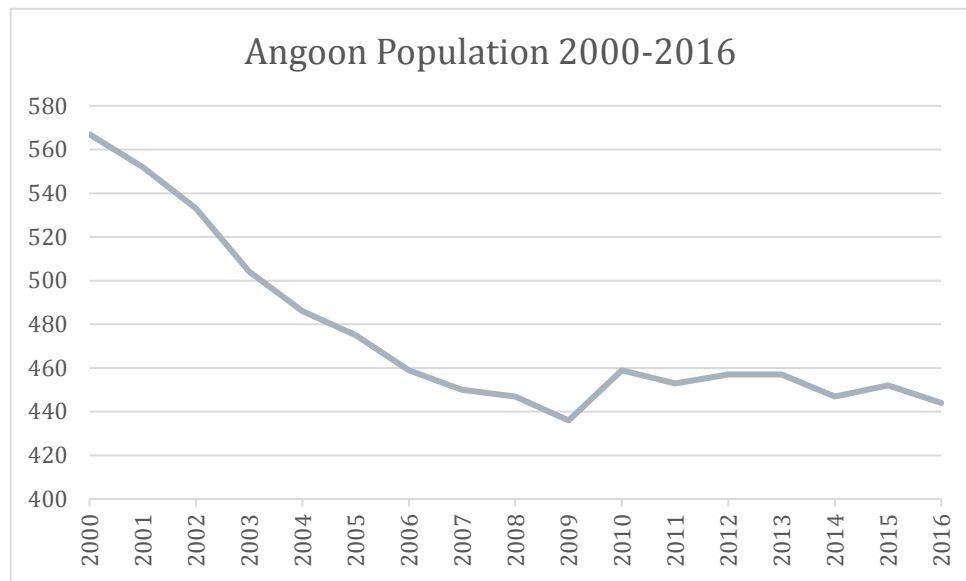

Figure 1 - Historic Angoon Population, 2000-2016

Tourism

Tourism continues to be the bright spot in Southeast Alaska’s economy – tourism is projected to grow 4% annually through 2020¹ and accounts for 19% of the region’s employment². Record numbers of cruise ship and airline passengers came through Southeast Alaska in 2016 and 2017².

¹ Southeast Alaska by the Numbers, 2015; Southeast Alaska Conference

² Southeast Alaska by the Numbers, 2017; Southeast Alaska Conference

A land-based airport has the potential to engender growth in tourism-related business in Angoon and Admiralty Island National Monument, particularly for ecotourism and independent travelers. Visitor-related opportunities such as sightseeing, flightseeing, community and wilderness touring, and sport-fishing are growing throughout the region. The Whaler's Cove Lodge, for example, located on Killisnoo Island 2 miles southwest of the city of Angoon, offers dining and accommodation, a fleet of over 20 vessels for sport fishing, wildlife and photo tours, and kayaking and canoeing. Favorite Bay Sportfishing Lodge, located just a mile southeast of the city of Angoon, likewise offers high-quality accommodations and wildlife and sport fishing tours. The opportunity for small-scale operators offering bookings through Airbnb or similar sites is essentially untapped, unlike in other communities in Southeast Alaska, such as Sitka, Juneau, Gustavus, and many others.

Commercial Fishing and Seafood Processing Infrastructure

Commercial fishing has been a major part of Angoon's local economy, but it has been less active in the past decade. Active crew licenses in the community for commercial fishing vessels ranged from 5 to 11 between 2009 and 2014, and 11 to 25 between 2000 and 2008. More than 15 vessels once fished halibut and salmon in the early 2000s, but since 2009 vessels have declined to just 1 or 2.

Subsistence Dependence: Reliance on subsistence resources is typical in many Native Alaskan communities. In remote locations such as Angoon where full-time employment opportunities are lacking, subsistence resource use is often quite high. Since annual statistics are not available for this non-commercial use, a subsistence survey from 1996 represents the best quality data.

In 1996, salmon and halibut harvests were 122.4 lbs/year per capita. If this subsistence harvest persists at the same level today, 36,372.5 lbs. of salmon and 17,968.7 lbs. of halibut would have been harvested in 2016. The headed-and-gutted wholesale price of this amount of salmon would have been \$92,386 to \$176,770. The headed-and-gutted wholesale price of this amount of halibut would have been \$145,546.

Medevac Operations The term "medevac" is an abbreviation for medical evacuation. This and other terms referring to a type of medical emergency response are used interchangeably in the United States. Other terms include "helicopter emergency medical service" and "air ambulance." The value of air access to remote locations or in the event of an emergency is not generally recognized until it occurs, and it is difficult to place an economic value on such capabilities. Oftentimes, the primary means of reaching a community immediately after a major act of nature such as a flood, earthquake, wildfire, or landslide is via air transport.

Both fixed wing aircraft and helicopters are used in medical emergency response situations. Patients are flown by fixed wing aircraft for many different reasons. These can range from the stable patient involved in an accident or with a long-term medical condition wishing to relocate closer to family for rehabilitative care, to the critical heart failure patient requiring intensive care transfer to receive a transplant. The fixed wing environment differs from the rotary wing environment primarily in that fixed wing aircraft travel farther, faster, and higher. Fixed wing aircraft are primarily used for facility-to-facility transport, typically over long distances; the aircraft include a range of

multi-engine turboprop and small jet aircraft specially equipped and staffed to respond to patient needs while en route. Rotary wing service is typically engaged for moving a patient from an accident or incident scene to a trauma center and for air transport of stable patients; these aircraft are also suitably staffed and equipped for these missions.

Not all medevac transport is associated with an emergency situation. Many medevac flights involve medically appropriate hospital-to-hospital transport on a scheduled basis. Therefore, medevac service providers are actively engaged in both emergency response and critical care transport.

Air transportation of patients between Angoon and Sitka or Angoon and Juneau is uncommon. There are no fixed-wing medevac operations that operate on floats, so all medical evacuations are done via helicopter. However, there are several fixed-wing medevac aircraft in the region that could be used at Angoon if a runway were built. Guardian Flight operates a KingAir B200 out of Sitka and Juneau, which serves Hoonah and Kake's medevac needs. Guardian Flight is the sole medevac provider for the Southeast Alaska Regional Health Consortium (SEARHC).

Healthcare SEARHC is a Native-run, non-profit health consortium that serves the healthcare needs of southeast Alaska residents. They operate community clinics and dental facilities, as well as the Mt. Edgecumbe Hospital in Sitka.

Residents of Angoon wishing to seek medical care beyond what is available at the local clinic must travel to Sitka or Juneau. SEARHC operates a Patient Travel Office that coordinates travel for rural residents to these facilities. As such, SEARHC would benefit from scheduled air service between Angoon and Sitka rather than chartering an aircraft as they currently do.

Scheduled Service Angoon receives daily air service from Juneau, with the number of daily flights changing seasonally. Alaska Seaplanes, which holds the Essential Air Service (EAS) contract, provides three flights daily in the summer and two flights daily in the winter. They also offer charter air service between Angoon and other communities such as Kake and Sitka.

Harris Air has provided scheduled air service sporadically in the past but does not offer it currently. They provide charter air travel to Angoon as needed. In discussions with them, Harris Air indicated interest in the construction of a land-based airport and providing scheduled air service between Sitka, Angoon, and Juneau.

Air taxi operators have indicated that a land-based runway could reduce the price of passenger tickets between Angoon and Juneau.

Forecast Method Because DOT&PF is evaluating runway length, width, orientation, and navigational aids, the most critical element to forecast at Angoon Airport is the number of operations for each aircraft type. This will dictate the runway dimensions.

The most demanding aircraft (wingspan and required runway length) currently using the Angoon Seaplane Base regularly is the **Cessna 208 Caravan**, which is used for air taxi operations. The regular use of this aircraft points to the potential of ADG II aircraft becoming the primary category of use for a land-based airport.

Angoon’s population has decreased by 22% since 2000, but this statistic is slightly misleading when considering the seasonal workers and guests that surge during the sightseeing and fish harvest season. In a community like Angoon, which is geographically isolated and has a small population, an unstable economic base, and poor transportation options, **a land-based airport is a potential generator of population growth and economic development.** More convenient and reliable land-based air transportation may influence seasonal workers as well as guests to establish residence year-round.

Likewise, the development of a land-based airport may induce additional passenger service options for travel from Angoon. For example, Harris Air has expressed an interest in including Angoon as a destination along their Sitka-Juneau route.

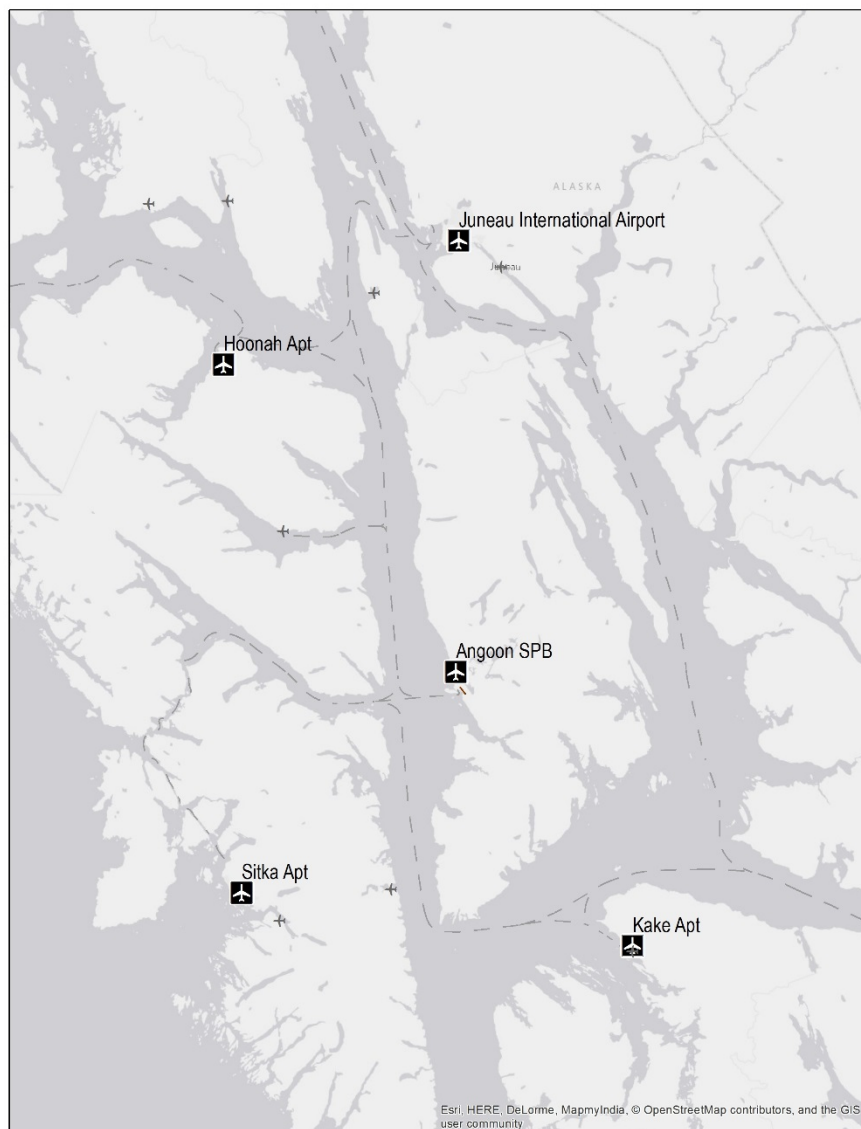

**Step 5 –
Apply Forecast
Methods and
Evaluate Results**

Angoon (2016 population: 444) is a majority Alaska Native community that is geographically isolated, has a population of less than 1,000, is accessible by ferry in southeast Alaska, and has an existing seaplane base. As part of this forecast, a comparison of the annual operations of three communities in southeast Alaska that generally fit into the aforementioned category of characteristics and which have an operating land-based airport. These communities are Hoonah, Kake, and Klawock.

Hoonah (2016 population: 745): Hoonah’s land-based airport generated 13 aircraft operations per resident in 2015, for an annual total of 9,855 operations. Using the same rate for Angoon’s current population of 444, an estimate for the base year would be **5,772** operations. Hoonah’s annual seaplane base aircraft operations are considerably lower than Angoon’s (in Hoonah, 1 operation for every 4 residents, and in Angoon, 4 operations for every 1 resident). With a land-based airport, land-based aircraft operations would supplant most seaplane operations, except for those operations which require the capabilities of a seaplane.

Kake (2016 population: 563): Kake’s land-based airport generated 8 aircraft operations per resident in 2015, for an annual total of 4,576 operations. Using the same rate for Angoon’s current population of 444, an estimate of a base year with **3,552** operations can be expected. Kake’s annual seaplane base aircraft operations are considerably higher than Hoonah’s (and lower than Angoon’s) with approximately 1 operation for every one resident annually.

Klawock (2016 population: 796): Klawock’s land-based airport generated 5.3 aircraft operations per resident in 2015, for an annual total of 4,160. Using the same rate for Angoon’s current population of 444, an estimate of a base year with **2,353** operations can be expected. There are zero recorded 2015 operations for the seaplane base.

An analysis of the limited socioeconomic data for these communities reveals a weak link between population/demographics and aircraft operations. The two most relevant factors in operations per population are accessibility to regular ferry service (by access road to another community or locally) and tourist demand.

Kake is an isolated community but with an undeveloped tourist infrastructure and a relatively undesirable natural environment for tourists. Kake’s geographic isolation makes regular ferry service infeasible—the community relies mostly upon air transport.

Klawock is less geographically isolated than our other examples, being just 5 miles north of Craig (population: 1,231 in 2016), accessible by road to other major communities and ports on Prince of Wales Island. It also has regular, reliable ferry service. Although Klawock, Craig, and Prince of Wales Island as a whole are popular tourist destinations, aircraft operations are not necessary nor desirable compared to ferry service.

Hoonah is geographically isolated and is not connected by road to another community. There is access to ferries, but service is unreliable. The city, and the island it is a gateway to, are popular tourist destinations with well-developed tourist infrastructure.

Angoon has characteristics mostly resembling a mixture of Kake and Hoonah. Because of the similarity in ferry service and tourism growth, it is reasonable to assume that annual operations may begin above Kake levels, and then grow towards Hoonah levels as the Angoon tourist market matures.

Base operations of **4,400 are proposed**. The increased economic activity from a land-based airport to bring Angoon’s population back to pre-2000 levels in the range of 550-600 persons, assuming the tourism market matures and the commercial fishing industry becomes sustainable. Fifteen years from start of airport operations, a forecast annual operations of **6,300 is expected**.

With the development of a land-based airport, it is reasonable to expect the eventual basing of local GA aircraft and, consequently, local GA operations. Likewise, with the construction of a land-based airport, the frequency of medevac operations is likely to increase.

Table 9 - Forecast Operations at (Prospective) Angoon Land-Based Airport

Operations	Base Year 2016	+5 Years	+10 Years	+15 Years
Air Taxi	4,050	4,653	5,236	5,810
Local GA	0	0	20	50
Itinerant GA	150	170	190	210
Medevac	200	210	220	230
Total Operations	4,400	5,033	5,666	6,300
Annual Growth Rate	--	3%	3%	3%

**Step 6 –
 Compare Forecast
 with TAF**

Table 10 summarizes the differences between this forecast and the TAF. The TAF for Angoon shows no change in the number of operations for the forecast period.

Table 10 - Forecast - TAF Comparison

	2016			2021			2026		
	Forecast	TAF	Difference	Forecast	TAF	Difference	Forecast	TAF	Difference
Local GA	0	0	0	0	0	0	20	0	20
Itinerant GA	150	150	0	210	150	60	190	150	40
Air Taxi	4,050	1,000	3,050	4,653	1,000	3,653	5,236	1,000	4,236



APPENDIX B

PUBLIC INVOLVEMENT PLAN

Meeting agenda in regular font; *notes from the meeting are in blue italics.*

Meeting Purpose

- Knowledge transfer from FAA's past works that will facilitate **efficient** development of the project design, environmental permitting and ROW acquisition
- Clear understanding of FAA's role in the process moving forward
- Discussion of strategies for handling changed conditions based on findings of the design work.
- Is there an acceptable level of changed conditions to keep compliant with the EIS?

Introductions – Name, Project Role

- *Mike Edelmann, FAA Planning; Project Manager through ALP development*
- *Ryan Feil, FAA Engineering; FAA Project Manager after ALP is approved*
- *Leslie Grey, FAA Environmental Program Manager; EIS author and resource*
- *David Pyeatt, DOT SC Project Manager*
- *Doug Blackburn, DOT SC Design Engineer*
- *Christopher Goins, DOT SC Design Group Chief*
- *Verne Skagerberg, DOT SC Acting Planning Chief*
- *Angela Smith, PDC Lead Engineer, Assistant PM*
- *Royce Conlon, PDC Project Manager*

Understanding of Design Basis of the EIS Site 12a

Clarity on Near Term Facility vs. Ultimate Plan

- Approach in Ultimate established for lower than $\frac{3}{4}$ mile, but approach study by others indicated $1\frac{1}{4}$ best could be achieved
- Affects if planning for Visual, NPI, or Precision approach; reference to all three within previous documents. Key effect for this near-term project is planning for:
 - Parallel taxiway/apron offset
 - ROW acquisition
- Setting profile to meet current with a cost-effective design at expense of future? Or bear costs now so future only needs extension, or some middle options?

*EIS determined a precision instrument runway and establishing precision instrument approach procedures would not be feasible or reasonable given the terrain and expense for extra earthwork that would be needed. **Obtained concurrence that the project will not need to plan for a parallel taxiway or property acquisition to protect the larger runway protection zones required for precision approaches.***

*Confirmed that the runway at Site 12a would be classified as a **utility runway and will be constructed to be used by propeller-driven aircraft of 12,500 pounds maximum gross weight or less.** Project to include 400-foot apron offset and runway lengths of 3,300 feet in the near-term and 4,000 feet in the long term. **Proceed with NPI approaches (minimums to be determined based on additional approach studies and runway alignment analysis).** Hopefully we can improve on the initial 1-1/4-mile with 1000-foot ceiling as identified in the EIS.*

*To have **opening day in 2021 with NPI approaches**, we will need to initiate flight procedures development by providing basic design information by mid-2018, because it can take as long as 3 years to get approaches approved. Ryan to provide information on the flight procedure portal submittal process.*

FAA is planning to obtain weather data at the airport site; preliminary discussions have been to relocate the weather station (ASOS) used for the floatplane operations to the airport site. Need to consider power and communication utilities during design.

***FAA feels it is reasonable to plan for longer-term development even if a bit more expensive.** It was noted that it is probably not reasonable to plan for 4,000' length if the cost to allow for future extension to 4,000 feet will be double as compared to an optimized 3,300-foot runway length. Evaluation should consider things like apron location relative to runway end to be extended (i.e., opposite end) such that future profile adjustment to accommodate the extension could have no or minimal effect on the taxiway/apron.*

Action Items:

- 1) PDC to coordinate with DOT to get approach analysis refined.*
- 2) Ryan to provide information on the flight procedure portal submittal process.*
- 3) PDC to add flight procedure follow ups to project schedule.*
- 4) FAA to advance coordination for relocation of the weather station for opening day (+/-).*

Initial Layout and Alignment Review

- Design level data is becoming available; terrain and geology different than anticipated
- Optimizing the site based on topography and geology
 - Shift and/or rotate runway alignment:
 - Balance of materials (cut/fill)
 - Impacts of clearing Part 77 obstructions
 - Clearing PAPI OCS
 - Changing apron location

Presented and walked group through packet provided at the meeting, which included draft design criteria, layouts for four alternatives with topography shown, summary of initial quantities, summary from initial geotechnical findings (hand probes and test pits). Additionally, graphics from the EIS approach study for Site 12a were included in the packet for discussion of potential improvements of the approach.

FAA indicated that there was a lot of flexibility within the site. FAA anticipated that adjustments would be made as the project proceeded to design. They felt (hoped) they had planned for “worst case.” Now that we have collected more recent and detailed information, there might be some key items that were not accounted for in the “worst case” scenario, such as the fact that there is substantially more earthwork than expected. Also, there will be a need to locate a waste disposal area for overburden and unsuitable excavation. FAA inquired where this waste material would go? Discussed that there is an expense for hauling it off as well as for placing it in wetlands (i.e., mitigation cost). The team will need to evaluate the options. It was noted that preliminary geotechnical work is still in process, so the information presented was very preliminary and the suitability and usable portion of the cut for use as fill still needs to be determined.

FAA based the EIS impacts on 4H:1V embankment sideslopes. Mike indicated that 4H:1V was FAA’s standard for sideslopes because it allows for ARFF vehicles to safely access the RSA from any location. ARFF vehicles are required at Part 139 certificated airports; since Angoon will not be a Part 139 airport, there may be flexibility with regard to the steepness of the sideslopes.

Leslie noted that any mitigations or project requirements included in the EIS must be incorporated into the design.

Besides potential improvement of approaches, the options that rotated the alignment potentially made a better balance of earthwork. Leslie noted that the realignments might even reduce noise over the community. She did note she would need to think about how it might affect the noise related to the Forest Service land, but given that the aircraft are small and the limited number of operations, that may be a non-issue.

Action Items:

- 1) DOT to continue with geotechnical investigation work to aid in refinement/optimizing of the layouts.
- 2) PDC to consider the knob on the north end in looking at options and make sure the Runway 30 approach doesn’t become obstructed.
- 3) PDC to advance the layouts once geotechnical work is complete...continue to work with FAA on what the impact changes might be and how that might affect the EIS findings.
- 4) FAA to provide the limits of work (boundary) covered in the EIS evaluation.

ROW Acquisition – Early Acquisition Opportunities

- Follow-up meeting

This topic was included to get a first take on what FAA’s thoughts were on early acquisition with the intent to discuss it further when all the right people (including ROW personnel) were in the room. **Key takeaways included:**

- Early acquisition is possible. DOT can advance the ROW and make acquisitions that will be eligible for reimbursement.
- FAA assumed that if any land was touched/impacted then the parcel would be acquired in full (no partial takes).

- *Discussed that with the alignment adjustments different parcels would be affected than originally planned; likely acceptable, because maybe it doesn't matter which exact parcels were affected, rather that similar numbers would be affected.*
- *Mike explained that for property acquisitions to be AIP-eligible there must be an aviation need.*
- *FAA stated that individual parcels may be acquired as standalone grants: it just means more paperwork.*
- *If a parcel needs to be acquired that was not included in the EIS, then a separate environmental document will be required. Depending on the situation, the document may be as straightforward as a Categorical Exclusion.*

Discuss Potential for a Partnering Meeting

- Best practice on project of this scale and history
- Risk assessment and early identification of methods to keep the project moving forward
- Development of communication plan and strategies for conflict resolution

Yes, all in room agreed this would be of value. Leslie felt the partnering meeting would be more effective if prior to meeting, the team reviewed more detailed information about the challenges to be worked through.

Action Items:

- 1) *PDC to seek out a facilitator, coordinate schedule, and develop agenda/topics for the meeting.*

Other Topics Discussed:

Airport Layout Plan (ALP) doesn't have to be complete and approved before we can move into Design. DOT has the option to advance the design work with an FAA design grant. At this point DOT plans to move forward without a design grant.

There was discussion if Form 7480-1 will need to be submitted to be assigned an airport location ID. Mike indicated he would check but thought the ALP review process takes the place of needing to submit it separately. If Form 7480-1 is required, it will be submitted with the ALP.

The EIS intended the project to use the City of Angoon barge landing with the agreement from the City that the barge landing would be improved beforehand. Additional barge landings were not included. Leslie noted this might be a key concern if the City is not moving forward with the improvement. David took this as a follow-up item.

Leslie indicated the project should permit any expected (highly likely) material sites to ensure they are covered as part of the environmental process prior to the project being approved for construction.

Action Items:

- 1) *Mike to advise on the need to submit Form 7480-1.*
- 2) *David to follow up on the City of Angoon's progress on improving the barge landing.*

Public Involvement Plan (Draft)

Angoon Airport—Design

DOT project # 00086
September 15, 2017

Prepared for:
Alaska Department of Transportation and Public Facilities

Prepared by:
HDR

This page intentionally left blank.

Table of Contents

1. Project Background and Description.....	<u>14</u>
2. Project Area	<u>2</u>
3. Public Involvement Overview.....	<u>33</u>
3.1 Potentially Affected Interests – Project Stakeholders.....	<u>33</u>
3.2 Environmental Justice	<u>44</u>
4. Roles and Responsibilities	<u>55</u>
5. Schedule and Activities	<u>55</u>
6. Reporting.....	<u>88</u>

Figures

Figure 1: Project Area Map	<u>2</u>
----------------------------------	----------

Tables

Table 1: Potential Stakeholders	<u>44</u>
Table 2: Minority and Low-Income Populations, 2016 Estimates.....	<u>44</u>
Table 3: Project Roles and Responsibilities	<u>55</u>

This page intentionally left blank.

1. Project Background and Description

Angoon is a small, rural community (population 408) on Admiralty Island in Southeast Alaska. Angoon is not connected to Alaska's road system, and access is currently provided by ferry and seaplane service. These water- and air-based services are dependent on weather and tides. While the Alaska Marine Highway System (AMHS) provides year-round ferry services to Juneau and summer services to other Southeast Alaska communities, service is infrequent and can be cancelled due to rough seas. Seaplane pilots are able to fly in the area only using visual flight rules, which require daylight hours, good weather, and good visibility.

In 2008, the Federal Aviation Administration (FAA) and the Alaska Department of Transportation and Public Facilities (DOT&PF) initiated environmental review for a project that would provide sufficient transportation availability and reliability to and from Angoon via a land-based airport. The FAA issued a Final Angoon Airport Environmental Impact Statement (EIS) and a Record of Decision (ROD) in 2016.

In August 2017, DOT&PF issued a contract for a refined layout and design based on the FAA's preferred alternative, 12a (Access 12a). Components of the design include:

- A paved 3,300-foot runway, which could be expanded to 4,000 feet at a future time
- Medium-intensity runway lights
- Location for a terminal or passenger shelter
- Runway safety areas, navigational aids, and visual approach aids
- Lease lots
- Passenger parking lot
- Support facilities (such as weather station and communication facilities)
- Access road
- Aircraft apron

The project will:

- Identify a final design for the runway and associated structures
- Identify potential changes in environmental impacts from the EIS due to design refinements
- Prepare final plans for construction
- Obtain necessary permits to construct the airport facilities
- Acquire right of way (ROW)
- Inform and involve the public and other stakeholders throughout the process to share information and gather feedback

Funding for the project is provided by an Airport Improvement Program (AIP) grant through the FAA. Construction is anticipated to begin after 2018.

2. Project Area

The City of Angoon (population 408) is located on Admiralty Island in Southeast Alaska (see Figure 1).

Figure 1: Project Area Map

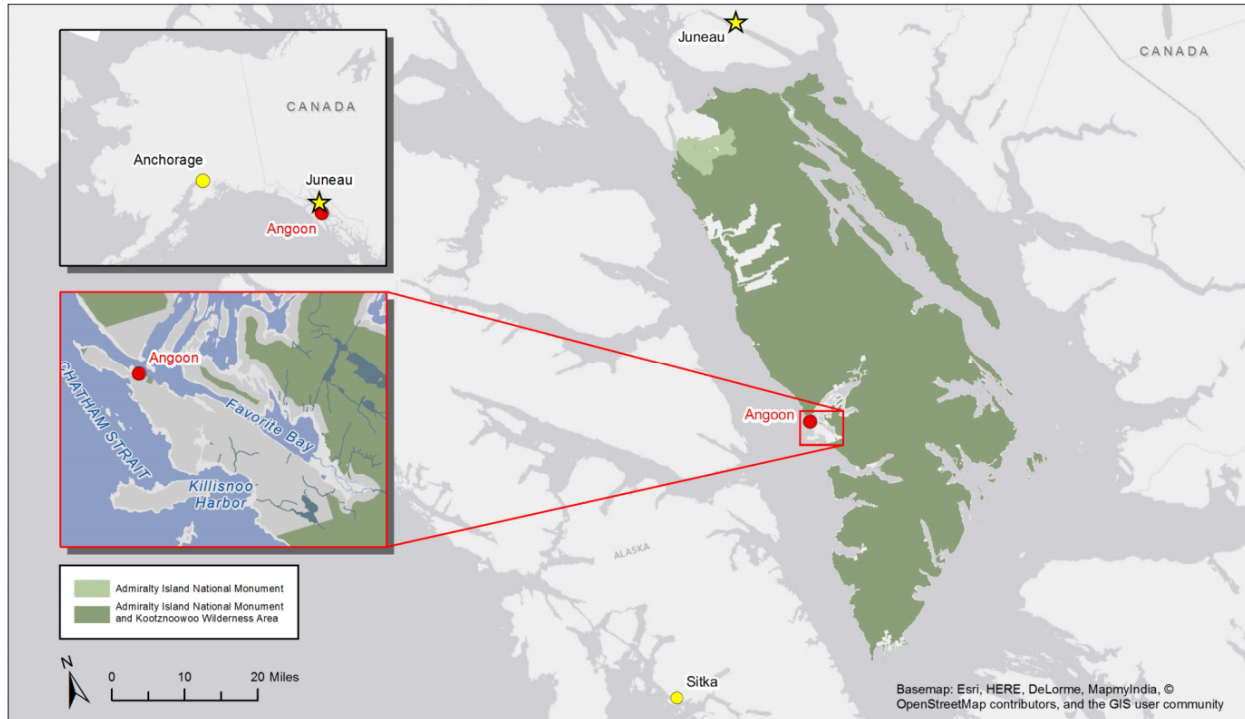

Source: Figure ES-1 of the Angoon Airport Final EIS, September 2016

EIS Preferred Alternative: 12a with Access 12a

The project area is located on lands owned or managed by private landowners; Kootznoowoo, Inc.; and the City of Angoon. Both the airport and the access road would be on the Angoon peninsula southeast of the community of Angoon; no part of this alternative would be located on Admiralty National Monument–Wilderness Area lands. Access to the 12a site would begin at the existing Bureau of Indian Affairs Road and travel directly to the proposed airport location.

Source: Angoon Airport Final EIS, September 2016

3. Public Involvement Overview

Angoon’s community members have an intense interest in the proposed construction of the land-based runway and support facilities. Educating the public about the design process, environmental constraints, and ROW requirements will require clear communication about the decisions made to date and what the community should anticipate during the project’s design and construction.

Considering the project’s history, stakeholders will need to be updated regularly on the current phase and how the project has moved from environmental review to design. Raising community awareness about the design team’s effort in the area is key to successful project implementation. Other issues that will need to be addressed include:

- ROW requirements
- Temporary and permanent easements
- Property access
- Timber rights
- Material requirements and subsurface estate
- Airport access
- Airport operations
- Noise (during construction and after airport opens)
- Construction schedule
- Community impacts

Identified Public Involvement Objectives:

- *Inform the public and stakeholders on the design process and schedule.*
- *Clarify the differences between past decisions and current efforts.*
- *Involve stakeholders in gathering meaningful feedback during the design process.*
- *Manage expectations by conveying anticipated design changes to the location of the airport facilities and roadway access.*
- *Acknowledge and respond to public comments.*
- *Comply with Title VI of the Civil Rights Act of 1964 and Title II of the Americans with Disabilities Act.*

3.1 Potentially Affected Interests – Project Stakeholders

Information sharing is at the heart of any public process. This public involvement plan focuses on this basic premise: DOT&PF commits to working with stakeholders to relay accurate and timely information related to the project’s design, and to ensure that stakeholder concerns related to the design are heard and, when possible, addressed.

The Angoon Airport--Design Project has numerous potential stakeholders, including area residents and businesses, recreational users, federal and state agencies, local government, and Alaska Native Tribes and corporations. Table 1 presents a list of potential stakeholders.

Table 1: Potential Stakeholders

<p>General Public Area residents Property owners</p> <p>Local Businesses Air taxi operators Tour operators Inside Passage Electrical Cooperative Emergency response providers Lodging operators Commercial business (e.g. grocery)</p> <p>Elected Officials City of Angoon Alaska State Senator Alaska State House of Representatives</p>	<p>Alaska Native Tribes and Corporations Angoon Community Association Sealaska Native Corporation Kootznoowoo, Inc. Central Council of the Tlingit and Haida Indian Tribes of Alaska</p> <p>State/Federal Agencies and Entities Federal Aviation Administration (FAA) Bureau of Indian Affairs (BIA) U.S. Forest Service (USFS), Chugach National Forest U.S. Army Corps of Engineers (USACE) U.S. Fish and Wildlife Services (USFWS) Alaska Department of Environmental Conservation (DEC) Alaska Department of Fish & Game (ADF&G)</p>
------------------------------------------------------------------------------------------------------------------------------------------------------------------------------------------------------------------------------------------------------------------------------------------------------------------------------------------------------------------------------------------------------------	------------------------------------------------------------------------------------------------------------------------------------------------------------------------------------------------------------------------------------------------------------------------------------------------------------------------------------------------------------------------------------------------------------------------------------------------------------------------------------------------------------------------------------------------------------------------------------------------------------

3.2 Environmental Justice

The poverty level for the Hoonah-Angoon Census Area (2016) is approximately 5.9 percent below that of the state as a whole, and a lower percentage of the population speaks a language other than English (typically Tlingit). Table 2 reflects the U.S. Census 2016 Estimate for the state of Alaska and the Hoonah-Angoon Census Area.

During the EIS process, the FAA found that there would be no disproportionate adverse effects to low-income or minority populations as a result of the project. Given the scope of the design phase of the project, DOT&PF will not conduct specific outreach under state and federal environmental justice regulations. The design team will monitor the project as it progresses and proactively address any environmental justice issues that arise.

Table 2: Minority and Low-Income Populations, 2016 Estimates

	Total Population Est.	% Below Poverty Level	Race % Non-white	Median Household Income (\$)	% Speak a Language other than English
Alaska	741,894	10.3	33.9	72,515	16.2
Hoonah-Angoon Census Areas	2,078	16.2	53.1	52,419	11.8

Source: <https://www.census.gov/quickfacts/fact/table/hoonahangooncensusareaalaska/BPS030216> Accessed 8/30/17

4. Roles and Responsibilities

Although the public has a vested interest in project outcomes, DOT&PF retains sole authority to make decisions related to the project, although FAA retains authority over EIS compliance. While stakeholder feedback will be considered by the design team, DOT&PF will ultimately finalize the project design. Table 3 provides the project roles and responsibilities, as well as contact information for key project team members.

Table 3: Project Roles and Responsibilities			
Individual	Title	Role	Contact Info
Dave Pyeatt	DOT&PF Project Manager	Project point of contact (POC) supervising contract performance. Dave is the single POC authorized to speak with the media and is responsible for final approval of all public messages prior to distribution. Manages Environmental, ROW, Survey, Geotechnical Activities being performed by DOT&PF functional groups	David.pyeatt@alaska.gov
Royce Conlon	PDC Project Manager	Responsible for overall project coordination. Royce is the direct line of contact for communicating with DOT&PF.	RoyceConlon@pdceng.com
Angela Smith	PDC Deputy Project Manager and Design Lead	Responsible for draft and final design. Angela will be the POC for HDR's comment coordination.	AngelaSmith@pdceng.com
Mark Dalton	HDR Contract Manager	Serves as strategic advisor for the project.	mark.dalton@hdrinc.com
Julie Jessen	HDR Public Involvement Lead	Responsible for public involvement strategy, message development, and Public Involvement Plan implementation.	julie.jessen@hdrinc.com

5. Schedule and Activities

Public involvement activities for this project will correspond to key milestones in the project's design. Three public open houses and three listening posts will be held in Angoon. Small group meetings will be held as necessary in Angoon and Juneau. The timeline for design phase-related communications in 2017 and beyond is estimated; actual dates will depend on project activities and updates.

Activities include:

- **Agency Coordination** – DOT&PF Environmental will be leading efforts to coordinate with participating state, federal, and local agencies. The DOT&PF Project Manager will closely coordinate efforts with the project team to make sure viewpoints from all affected agencies are addressed and incorporated in the public involvement and design processes.
- **Public Open Houses (3)** – The project team will host public open house meetings at project kickoff, 35% design phase, and 75% design phase with the goal of informing stakeholders of the design process, issues, and schedule. The kickoff meeting will focus on project status and next steps, while the 35% and 75% design meetings will seek community feedback on project findings (i.e. options for optimizing the airport layout on the selected alternative (12A) since the EIS). Public input will aid in further evaluation of these options and identify potential mitigation opportunities for identified impacts (i.e. traffic control measures for hauling imported materials through town). Each meeting, listening post, and open house (both public and online) will be advertised in advance to provide sufficient public notice via:
 - Postcard to all Angoon mailboxes
 - Social media (DOT&PF’s Facebook page, any Angoon community pages)
 - State of Alaska Online Public Notice, GovDelivery
 - Paid print ads (*Juneau Empire*)
 - Radio ads (KINY AM, KTOO, and KCAW)
- **Online Open Houses (3)** – Online open houses will correspond with public open houses. Each online meeting will be available for 2-week period following each in-person open house and will include the same informational materials, graphics, and maps. Individuals visiting the online open houses will be able to submit comments online.
- **Listening Posts (3)** – Project staff will be stationed with eye-catching project graphics, maps, and materials at centrally located sites in Angoon prior to project open houses. The public involvement team will engage with members of the public, gather feedback, and increase the project’s visibility.
- **Small Group Meetings** – Meetings with interested stakeholders such as Tribal organizations, business groups, and others will be held periodically during the design process or as requested.
- **Informational Materials** – Materials will include handouts such as fact sheets and FAQs, as well as flyers and electronic newsletters. All materials will be updated prior to public and online open houses.
- **Website** – The DOT&PF-hosted website will provide up-to-date information to interested parties and a “join our list” option for site visitors to automatically sign up for e-newsletters and leave comments. HDR will provide draft language and materials to DOT&PF for inclusion on the website.
- **Comments and Responses** – These will be tracked throughout the project. Comments will be tracked using a spreadsheet; responses will be drafted by HDR and reviewed by

PDC before submittal to DOT&PF. HDR will then send approved responses directly to the commenters. DOT&PF staff should forward any public comments and their responses to HDR for tracking and to ensure a complete record.

- **Contact List** – A project-specific Mail/Contact List of agencies, organizations, elected officials, and others with an interest in the Angoon Airport--Design project will be continuously maintained. The mail/contact list from the EIS will be used as a starting point for an updated contact list.

6. Reporting

Meeting notes will be provided after each small group meeting, and summary reports will be developed at the conclusion of each public meeting. Summary reports will include information on meeting purpose, outreach mechanisms, materials provided, attendance, and comments received. This information will be incorporated into the project Scoping Summary Report and Plans-in-Hand report. A final public involvement summary report will be prepared at the conclusion of the project.



APPENDIX C

LOCATION STUDY

TECHNICAL MEMORANDUM

Client #	IRIS # SFAPT00086	Date	December 11, 2017
PDC #	17171JN	Prepared by	Ken Risse, PE Brian Hanson, PE
Project Name	Angoon Airport	Reviewed by	Royce Conlon, PE Angela Smith, PE
Subject	<i>Initial Concept Layouts/Location Study</i>		

Topic	Discussion
Introduction	<p>Angoon is the only permanent settlement on Admiralty Island and is located about 55 miles south of Alaska's capital, Juneau. The community of Angoon is currently accessible only by seaplane and ferry. These options do not provide sufficient availability and reliability in transportation to and from Angoon. DOT&PF proposes to construct a new land-based airport to improve the availability and reliability of transportation services. The new airport, which would accommodate small, wheeled aircraft, would include a single runway with an apron comparable to other rural airports in Southeast Alaska. Runway lighting would allow a pilot to land at night or during low-light condition. The development of instrument approaches would allow the pilots to navigate to and land at the new airport during instrument meteorological conditions (not currently an option).</p>

Background	<p>A land-based airport at Angoon has been a goal for DOT&PF and the community of Angoon since the 1980s. The Angoon Airport Reconnaissance Study (February 1983) recommended a site that was not favored by the community. The Angoon Airport Reconnaissance Study (April 2004) recommended a different site than the proposed site and was supported by the community. The Angoon Airport Master Plan (May 2007) was developed for a new airport at that site.</p> <p>An Environmental Impact Statement (EIS) was prepared for evaluation of various airport alternatives, and the FAA record of decision documents the selection of Alternative 12A as the environmentally preferred alternative. This location is approximately two miles southeast of the community, with a runway oriented NW to SE located west of an existing road to the water reservoir (BIA Road).</p> <p>DOT&PF provided the following information and resources at the start of the project:</p> <ul style="list-style-type: none"> • LIDAR based mapping (2-foot contours) • Ortho photography • Geotechnical exploration maps of probe and test pit locations and initial findings <p>Other background information was found in the EIS and supporting appendices.</p>
-------------------	------------------------------------------------------------------------------------------------------------------------------------------------------------------------------------------------------------------------------------------------------------------------------------------------------------------------------------------------------------------------------------------------------------------------------------------------------------------------------------------------------------------------------------------------------------------------------------------------------------------------------------------------------------------------------------------------------------------------------------------------------------------------------------------------------------------------------------------------------------------------------------------------------------------------------------------------------------------------------------------------------------------------------------------------------------------------------------------------------------------------------------------------------------------------------------------------------------------------------------------------------------------------------------------------

P:\2017\17171JN-Angoon_Airport\5Rpts\Scoping Summary Report\Appendix E location study\backup\17y12m08d - Location Memo - 17171JN.docx

ANCHORAGE	FAIRBANKS	JUNEAU	PALMER	SOLDOTNA
2700 Gambell Street, Suite 500 Anchorage, AK 99503 907.743.3200	1028 Aurora Drive Fairbanks, AK 99709 907.452.1414	6205 Glacier Highway Juneau, AK 99801 907.780.6060	125 W. Evergreen Avenue, Suite 102 Palmer, AK 99645 907.707.1215	170 E. Corral Avenue, Suite 2 Soldotna, AK 99669 907.420.0462

Topic	Discussion
-------	------------

Design Criteria The design criteria for the new not lower than 1 mile visibility minimums airport is based the aircraft forecasted to fly into Angoon after the airport is constructed. Airport design criteria are based on the guidance in FAA AC 150/5300-13A – Airport Design. The design aircraft is a small or utility airplane (under 12,500 pounds), Airplane Design Group (ADG) II, Aircraft Approach Category B. A visibility minimum of not lower than one mile was used to select the design criteria for the concept development. Provisions will be made to ensure the airport can accommodate future expansion. The forecast and design criteria are documented in the technical memo “Forecast of Aviation Activity & Facility Requirements” (December 2017).

For development and evaluation of initial concepts, only the primary elements of the airport facilities were considered. Key dimensional standards used in the initial evaluation are tabled below.

Dimension	Size	Dimension	Size
Runway Length	3,300’ (4,000’ ultimate)	Taxiway Safety Area Width	79’ minimum
Runway Width	75’	Apron and Aviation Support Area	475’ x 500’
Runway Safety Area Width	150’	Apron Offset from Runway Centerline	400’ desired 250’ minimum
Runway Safety Area Length beyond Runway End	300’	Maximum Apron Grade	2% maximum
Profile Grade	2% maximum		

Initial Concepts A pre-design kickoff meeting was held in September 2017 with the FAA, DOT&PF, and PDC to get an understanding of the design basis of the FAA preferred alternative and of the flexibility of the design within the selected site. Concepts that rotated the runway alignment and moved the apron location were discussed, and the FAA indicated there was a lot of flexibility within the site to allow these adjustments to the alignment and apron locations. Studies prepared for the EIS determined that precision instrument approaches were not feasible in Angoon. FAA confirmed that the airport should be designed for non-precision instrument (NPI) approaches and utility aircraft, and to plan for an initial runway of 3,300 feet and ultimate runway length of 4,000 feet.

PDC prepared four initial concepts—Alpha, Bravo, Charlie, and Delta—to compare the advantages and disadvantages of different runway alignments and apron locations. A field reconnaissance was conducted on October 4–5, 2017. Based largely on the results of hydrology and geotechnical probe and test work done during the field reconnaissance, a fifth concept, Echo, was added.

Discussion of these concepts follows. Figures depicting the concepts are appended.

General Site All of the concepts are located in the same general area, approximately two miles southeast of the community, with a runway oriented NW to SE placed west of an

Topic	Discussion
Alpha Concept	<p>existing road to the water reservoir (BIA Road). See Appendix B, Initial Concept Layout. The area is undeveloped, rolling terrain generally sloping to the southwest. Very large trees are found in the higher ground, and dense brush covers the lower, saturated ground. There are several streams crossing the area. As part of analyzing each concept, a hydrology review was performed. A copy of the review and comments on each concept are included in Appendix C. All the concepts avoid Native Allotment properties southwest of the runway, which would require a lengthy, difficult process to acquire for airport use.</p>
<i>Hydrology</i>	<p>A deeply incised stream crosses the runway alignment near the midpoint of the runway.</p>
<i>Geotechnical</i>	<p>Probing indicates organic and soft soils to a depth of greater than 10 feet on the north end of the runway and 2-4 feet on the south end. Probes in the apron area indicate soft soils to a depth of 6-10 feet.</p>
<i>Alignment and Approaches</i>	<p>The Alpha alignment was selected as the preferred alternative during the EIS alternative development. The PAPI OCS can be cleared of tree penetrations on the north end, but the south end has terrain penetrations 4 miles out that are not practical to remove. The north end of the runway is approximately 16 feet higher than the south end.</p>
<i>Earthwork Quantities</i>	<p>There are fills greater than 20 feet deep in the mid-section and south end of the runway along the centerline. The quantity of fill required for the embankment is approximately 200,000 yards more than the other concepts. The quantities for this concept will be used to compare the cost and environmental impacts of other concepts.</p>
<i>Apron Location</i>	<p>The apron was placed near the north end of the runway. The apron offset of 500 feet was based on the offset of the previous master plan because at the time the facilities requirements effort was not complete. The master plan used the FAR Part 77 guidance for a precision instrument approach (1,000-foot-wide primary surface) in setting the apron offset. This large offset may have been the reason that during the EIS process the apron was placed on the lowest ground on the east side of the runway, to minimize the excavation needed to keep the apron and parked aircraft from penetrating the Part 77 airspace. If this concept is carried for further evaluation, the apron offset could be reduced and the apron would likely be relocated.</p>
Bravo Concept	<p>The Bravo concept was based on the same alignment as the Alpha concept, but moves the thresholds 600 feet northeast along the alignment to reduce the volume of fill at the south end of the runway. The runway is located on rolling terrain, bearing approximately S 36° E.</p>

Topic	Discussion
Hydrology	Similar to the Alpha concept, a deeply incised stream crosses the runway alignment near the midpoint of the runway.
Geotechnical	Probing indicates organic and soft soils to a depth of greater than 10 feet on the north end of the runway and 2-4 feet on the south end. Probes in the apron area indicate soft soils to a depth of 2-8 feet, only slightly better than the Alpha concept.
Alignment and Approaches	The Bravo alignment matches the orientation of the Alpha concept, just shifted to the north. The PAPI OCS can be cleared of tree penetrations on the north end, but even with the shift of 600 feet, the south end has terrain penetrations 4 miles out that are not practical to remove. The north end of the runway is approximately 16 feet higher than the south end.
Earthwork Quantities	Shifting the apron from the location shown on Alpha to be near the south end of the runway changed the earthwork balance. Substantially more excavation would be needed to bring the apron elevation low enough to maintain the design criteria of less than 2% slope.
Apron Location	The apron was shifted to the south end of the runway to avoid placing it directly in the low part of the drainage. The 500-foot apron offset from runway centerline used for the Alpha concept was matched in Bravo, with the same rationale (meets instrument approach requirements), although this is now known to be an unnecessary constraint.
Charlie Concept	The Charlie concept was prepared as an attempt to obtain clear PAPI obstacle clearance surfaces on both ends of the runway. The runway is located on rolling terrain, bearing approximately S 19° E.
Hydrology	The runway embankment crosses two drainages higher on the hill where the channels are not as well defined as for the Alpha and Bravo concepts.
Geotechnical	Probing on the south end of the runway alignment indicates organic and soft soils to a depth of 4.5 feet. On the north end of the runway, probing was not as extensive, but probes taken in areas with similar vegetation indicated organic and soft soils to a depth of 10 feet. A single probe in the apron area indicated soft soils to a depth of 8.5 feet. If this concept moves forward, additional soil exploration is recommended.
Alignment and Approaches	The Charlie alignment is skewed approximately 17 degrees clockwise from the Alpha concept and shifted slightly to the south. It appears from preliminary analysis that the PAPI OCS can be cleared of terrain and tree penetrations on both the north and south ends. The runway orientation was set to avoid terrain and tree penetrations of the obstacle clearance slope (used 2.833° OCS for non-jet aircraft) approximately 4 miles out from the south end of the runway. The north end of the runway is approximately 16 feet higher than the south end. If this concept moves forward, a more detailed approach analysis will be required to determine if this concept offers improved approach minims.

Topic	Discussion
<i>Earthwork Quantities</i>	The north end of the runway is in fill across relatively flat terrain. Higher ground near the midpoint of the runway would be excavated, along with terrain penetrations of the primary surface on the uphill side of the runway. If the excavated material below the organics and soft soils encountered in the geotechnical probing is suitable for embankment, the runway profile could be adjusted to improve the material balance and reduce imported borrow. On the south end of the runway, the fill slopes on the west side are up to 65 feet high.
<i>Apron Location</i>	The apron was set in a relatively flat area on the east side of the runway to minimize the earthwork and was reduced from that of the previous concepts to avoid disturbing the existing road and power lines. Concept Charlie's entrance taxiway does not meet the guidance of the current AC 150/5300-13A, which discourages taxiway/runway intersections in the middle one-third of the runway. If carried forward, further development of this concept would revise the apron location. The runway offset could be reduced further, and the apron could be shifted to the north.
Delta Concept	The Delta concept was prepared as a revision to the Charlie concept to explore the option of realigning the road and siting the apron on what appeared to be better soils. The runway is located on rolling terrain, bearing approximately S 24° E.
<i>Hydrology</i>	The runway embankment crosses two drainages higher on the hill where the channels are not as well defined as for the Alpha and Bravo concepts.
<i>Geotechnical</i>	Probing on the south end of the runway alignment indicates organic and soft soils to a depth of 4.5 feet. On the north end of the runway, probing was not as extensive, but probes taken in areas with similar vegetation indicated organic and soft soils to a depth of 10 feet. A single probe in the apron area indicated soft soils to a depth of 1.5 feet, substantially less than other concepts. If this concept moves forward, additional soil exploration is recommended.
<i>Alignment and Approaches</i>	The Delta alignment is skewed approximately 12 degrees clockwise from the Alpha concept and shifted slightly to the north. The PAPI OCS can be cleared of terrain and tree penetrations on the north end, but the south end has terrain penetrations 4 miles out that are not practical to remove. The south end of the alignment was shifted up the hill to avoid some of the steeper terrain, reducing embankment height. The north end of the runway is still approximately 16 feet higher than the south end.
<i>Earthwork Quantities</i>	The north end of the runway is in fill across relatively flat terrain. Higher ground on the south end of the runway would be excavated, along with terrain penetrations of the primary surface on the uphill side of the runway. If the excavated material below the organics and soft soils encountered in the geotechnical probing is suitable for embankment, the runway profile could be adjusted to improve the material balance and reduce imported borrow.
<i>Apron Location</i>	This concept explored the option of placing the apron near the south end of the runway and relocating the existing road. Some of the approximately 300,000 cubic

Topic	Discussion
Echo Concept	yards of excavation required for the apron is likely to be suitable as embankment material for the runway construction. The apron offset from runway centerline was set at 400 feet, the minimum offset used for these concepts.
Hydrology	The design team prepared the Echo concept following a site visit in October 2017. This option would place a greater part of the runway on better soils and avoid streams where possible. The runway is located on rolling terrain, bearing approximately S 30° E.
Geotechnical	A deeply incised stream crosses the runway alignment near the midpoint of the runway.
Alignment and Approaches	Probing on the north end of runway alignment indicates organic and soft soils to a depth of 2-6 feet; probing on the south end of runway alignment indicates organic and soft soils to a depth of 2-5 feet. Two potential aprons were considered. Probes in the area of the north apron indicate organic and soft soils to a depth of 1-7 feet. The south apron probes indicate organic and soft soils to a depth of 3-8.5 feet.
Earthwork Quantities	The Echo alignment is skewed approximately 6 degrees clockwise from the Alpha concept and shifted approximately 1,000 feet to the north. The PAPI OCS can be cleared of terrain and tree penetrations on the north end, but the south end has terrain penetrations 4 miles out that are not practical to remove. The alignment was shifted to the north to avoid the deep fills and steeper terrain on the south end. The north end of the runway is approximately 16 feet higher than the south end.
Apron Location	The center portion of the runway is in fill across relatively flat terrain. Higher ground on the north and south ends of the runway would be excavated, along with terrain penetrations of the primary surface on the uphill side of the runway. If the excavated material below the organics and soft soils encountered in the geotechnical probing is suitable for embankment, the runway profile could be adjusted to improve the material balance and reduce imported borrow. The north apron option would result in a greater quantity of excavation, and that material is more likely to be usable for construction of the embankment.
	For both the north and south apron options, the apron offset from runway centerline was set at 400 feet, the minimum offset used for these concepts. The north apron option is on the hill about midway between the existing quarry and the north end of the runway. Terrain would be excavated to bring the elevation down to meet design grade limitations. Where the excavated material is suitable for embankment, extending the excavation laterally may provide additional material for runway construction. The south apron option was set in the lower ground on the east side of the runway to reduce the amount of excavation needed to meet grade requirements. Excavation from this area is not expected to be usable. If carried forward this apron location should be dismissed.

Topic	Discussion
Concepts Dismissed: Bravo and Delta	<p>The Bravo concept showed a slight improvement over Alpha due to apron location and earthwork volumes, but this concept was still poorly located relative to drainage, soils, and topography, not an appreciable improvement over Alpha. It was decided to drop Bravo and carry forward the EIS preferred Alpha concept for further comparative analysis. Revisions that would improve the Alpha concept if Alpha shows advantages over the other concepts advancing include changing the apron location. Otherwise, it is planned to retain Alpha for purposes of comparing other concepts to analyze the environmental impacts.</p> <p>The Delta concept did not provide a benefit over the similarly aligned Charlie concept, and the added cost and effort of relocation of the road, electrical lines, and water lines serving the community helped to eliminate this concept from further consideration.</p>
Evaluation	<p>It is recommended that three concepts move forward: Alpha, Charlie, and Echo. As we move forward with the more detailed evaluation process, the refined concepts will now be called alternatives. Refinements to the alternatives will be made as additional information becomes available. A more detailed evaluation process will be followed to determine the best possible alternative.</p> <p>Evaluation criteria used to assess the advantages and disadvantages of the three remaining airport alternatives are divided into three categories: safety, environmental impacts, and quality design.</p> <p>An evaluation matrix has been prepared to weight the elements of each category, score the alternatives for each criterion, and compute the weighted scores for each alternative. The alternatives evaluation criteria and scoring matrix are included in the appendices.</p>
Conclusion	<p>Three concepts—Alpha, Charlie, and Echo—will be carried forward for evaluation and selection of an engineering preferred alternative. The selected alternative will be the basis of the Airport Layout Plan and further environmental review.</p>

Appendices:







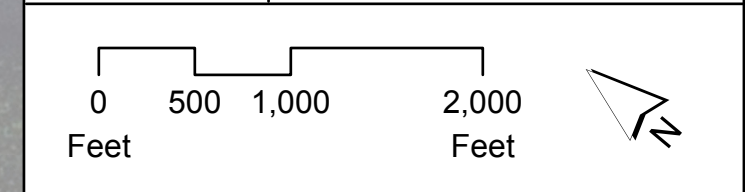
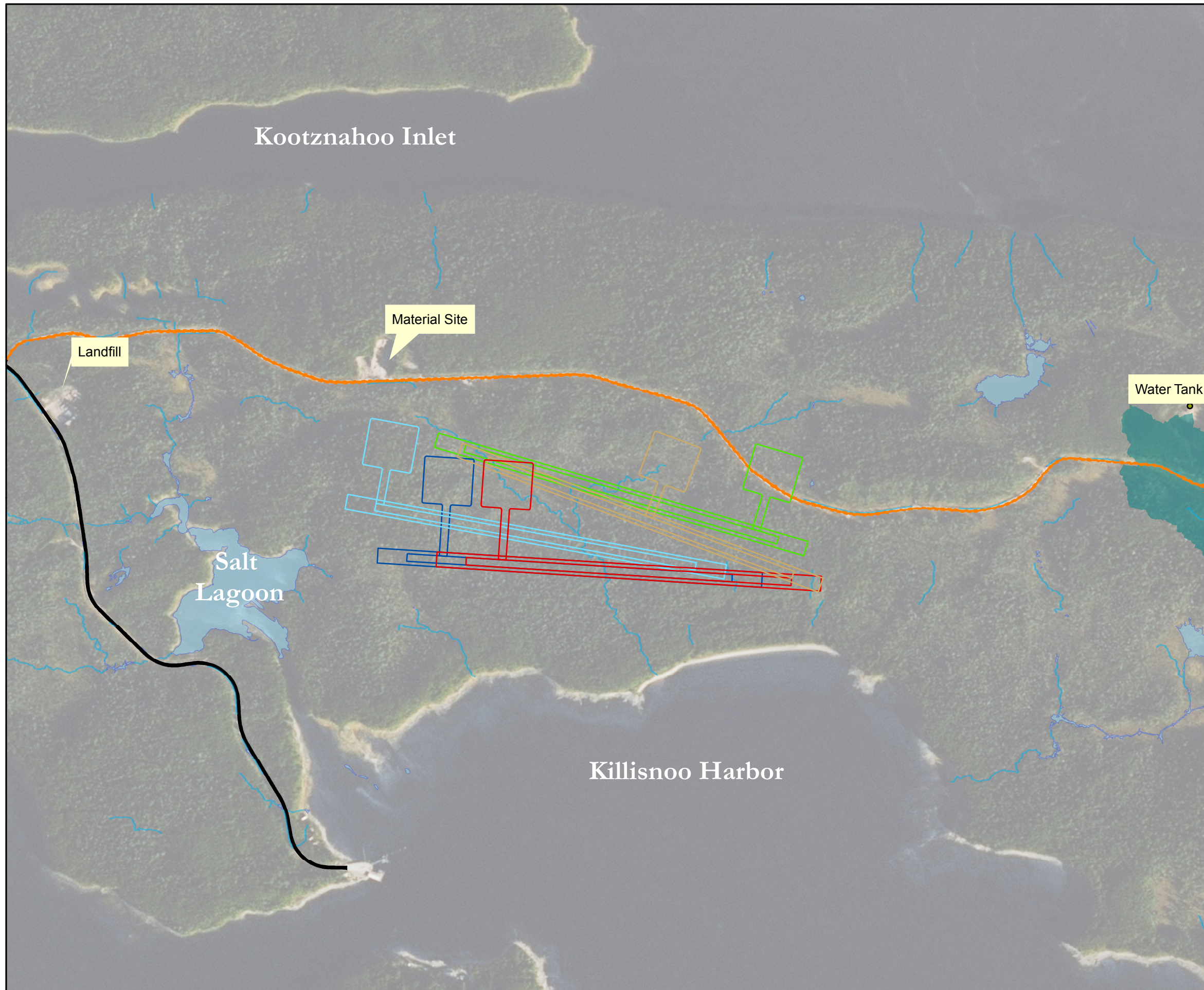

- A. Concept Figures:
 - a. Initial Concepts Layout
 - b. Alpha
 - c. Bravo
 - d. Charlie
 - e. Delta
 - f. Echo
- B. Alternatives Evaluation Criteria
- C. Alternatives Evaluation Matrix
 - a. Scores
 - b. Weighted Scores

APPENDIX A

CONCEPT FIGURES

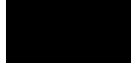

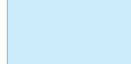
Legend

	Alpha		Streams
	Bravo		ROAD UNPAVED
	Charlie		ROAD PAVED
	Delta		POND
	Echo		Watershed

LAYOUT CONCEPT - ALPHA

SCALE: 1" = 1000'
12/05/2017

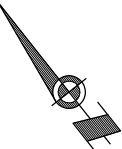

LAYOUT CONCEPT - BRAVO

SCALE: 1" = 100'
12/05/2017

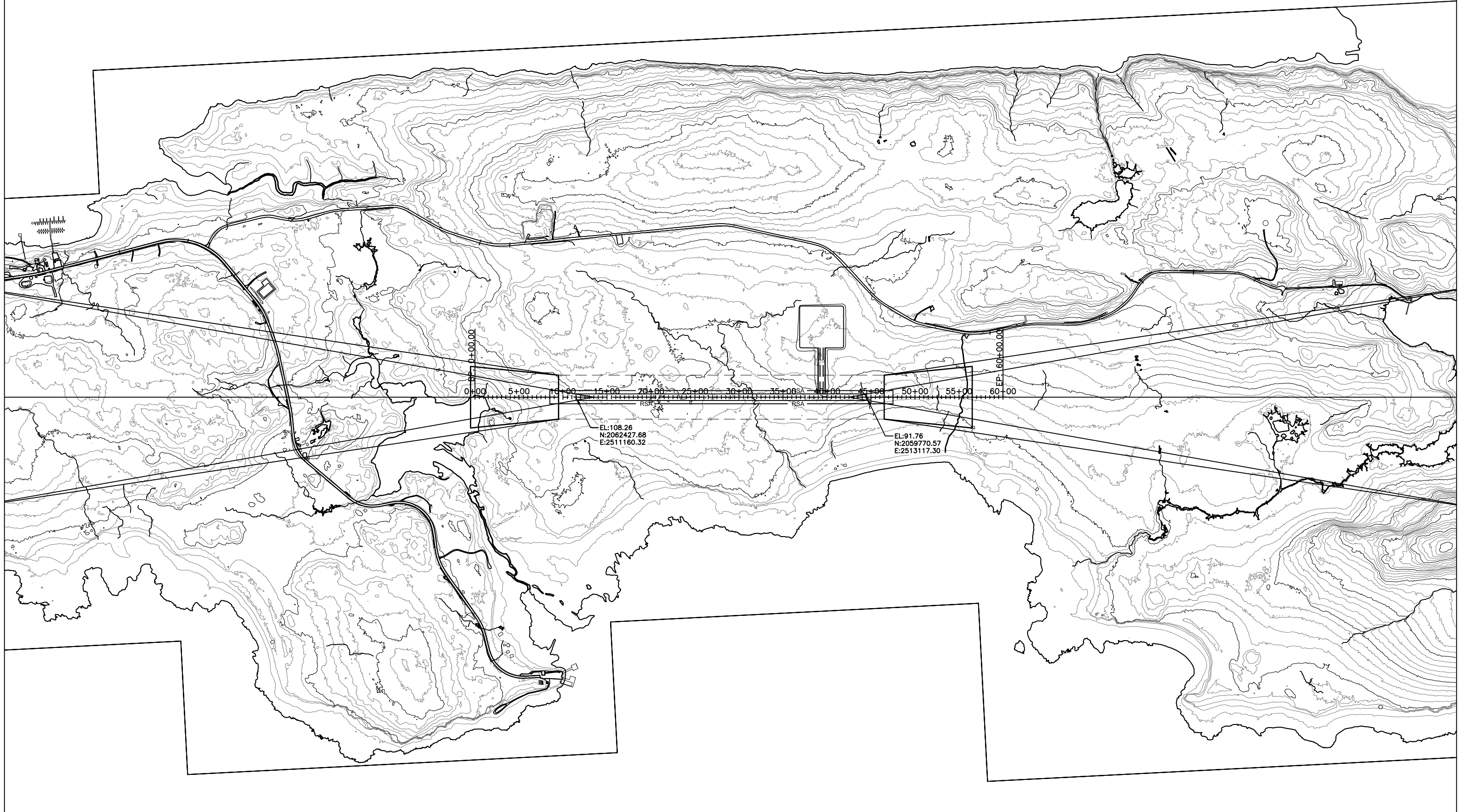
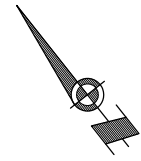

LAYOUT CONCEPT - CHARLIE

SCALE: 1" = 1000'
12/05/2017

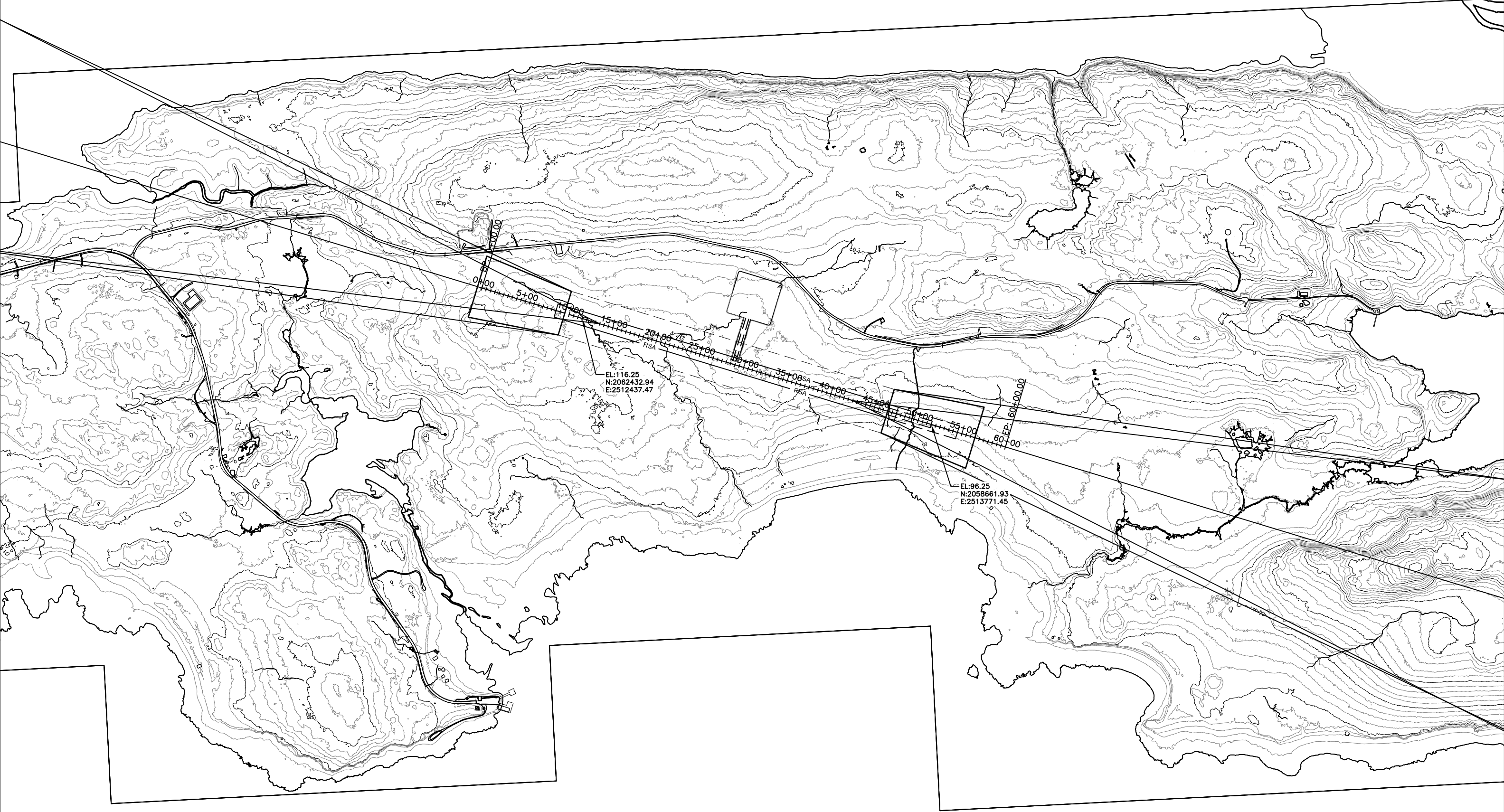
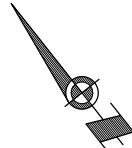

LAYOUT CONCEPT - DELTA

SCALE: 1" = 1000'
12/05/2017

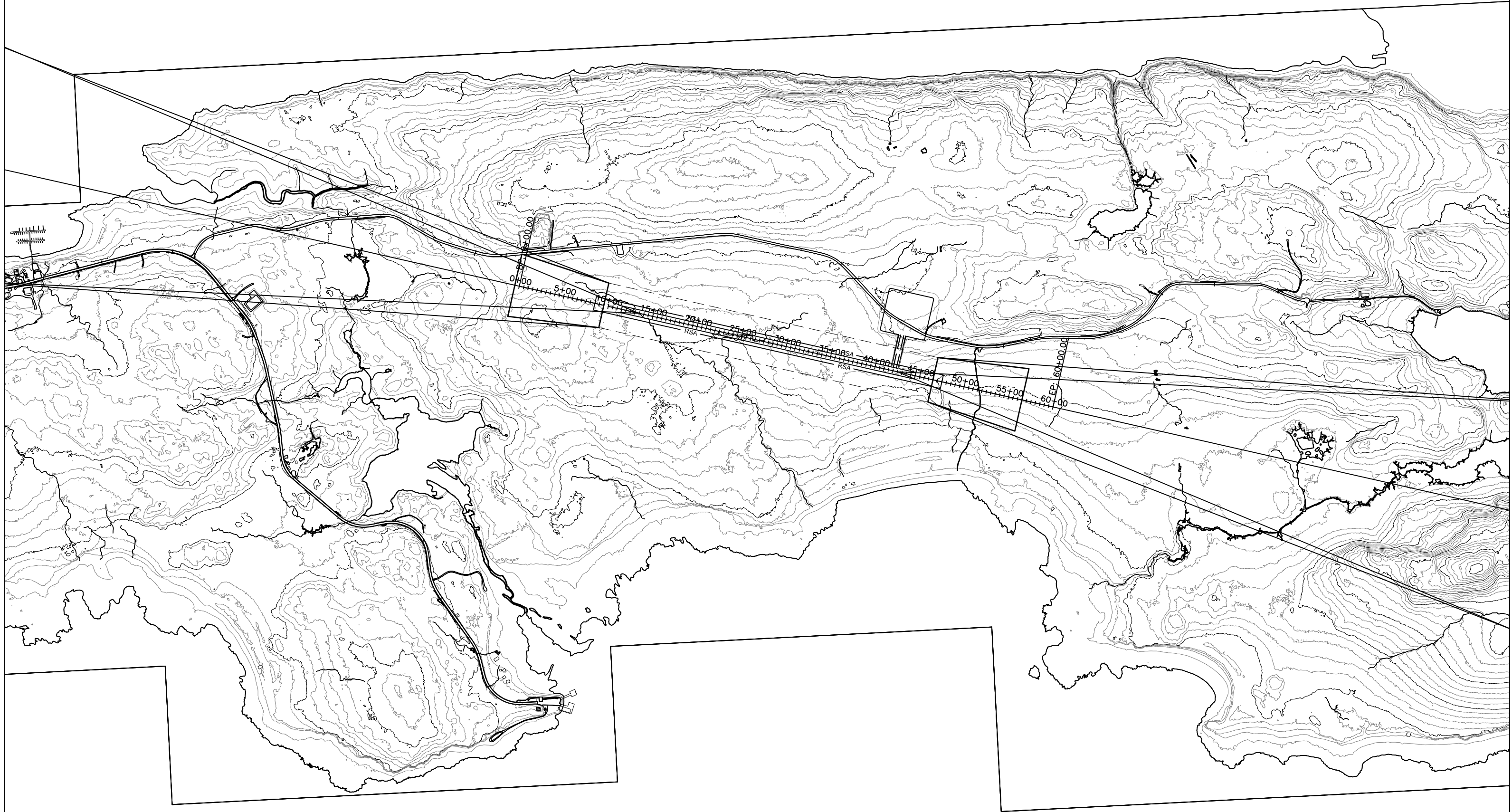
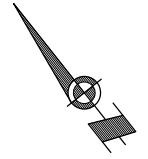

LAYOUT CONCEPT - ECHO

SCALE: 1" = 100'
12/05/2017

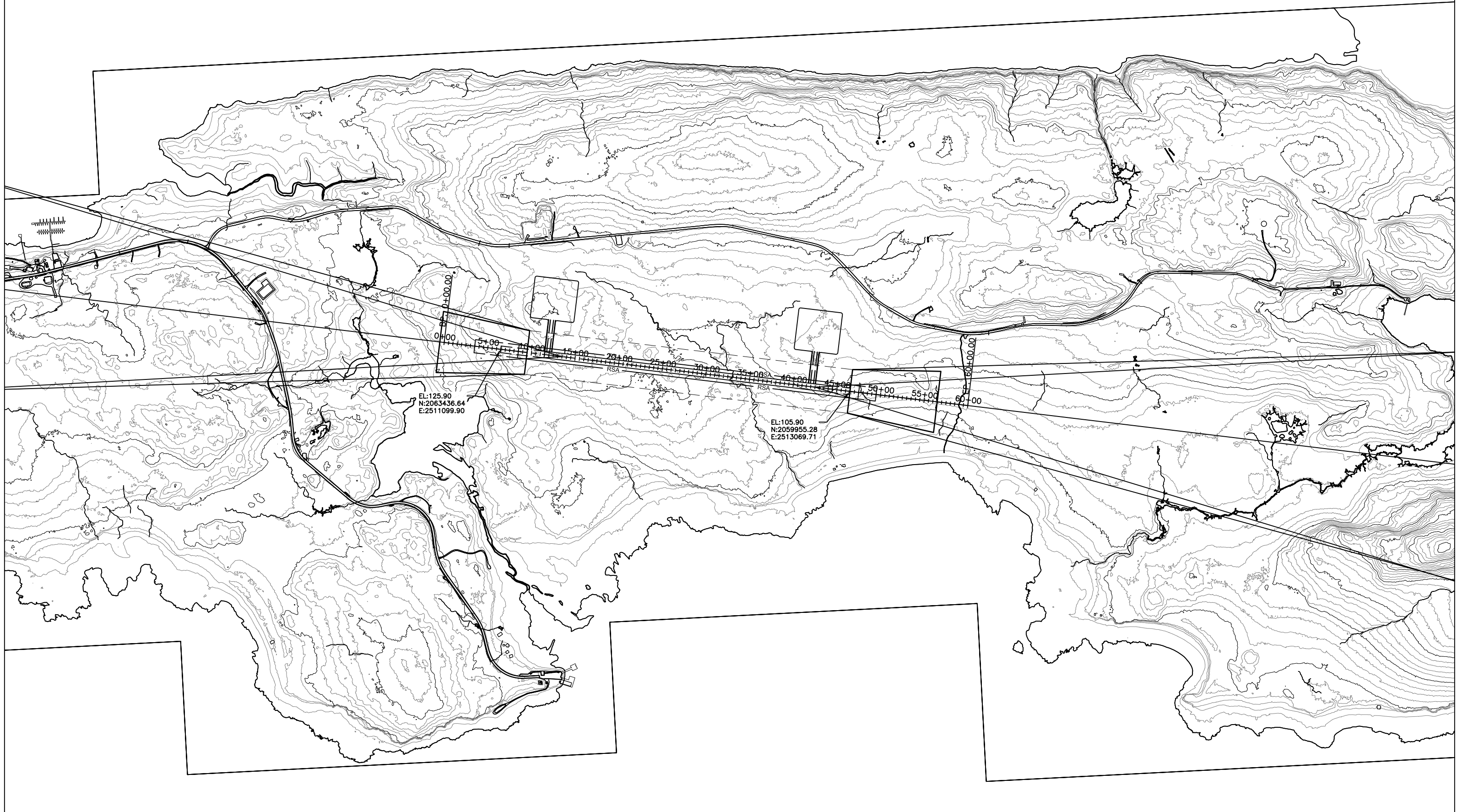
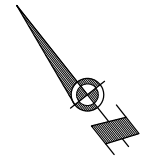

APPENDIX B

ALTERNATIVES EVALUATION CRITERIA

Angoon Airport – Alternative Evaluation Criteria

The following evaluation criteria will be used to assess the advantages and disadvantages of the three remaining airport alternatives. The criteria are divided into three categories: safety, environmental impacts, and quality design. Each alternative will receive a score of 1 to 10 for each criterion, a score of 10 is best and 1 is worst. A neutral score of 5 should be assigned where there is not a clear difference between alternatives.

Safety

Approach Capabilities: Approach limitations are often caused by terrain penetrations which can affect the approach minimums. Also approach/departure over schools or fuel facilities are less desirable. Further, the approach capabilities of a site affect ability to land during poor weather conditions or night operations, especially important when needing medevac capabilities.

Wind Coverage and other Meteorological Conditions: (N/A)

Wind coverage and adverse weather conditions affect day-to-day operations. Wind coverage affects the runway orientation. The higher the percentage of wind coverage a runway has the more optimal the runway alignment is. The FAA requires a minimum of 95% wind coverage. Wind data obtained from the FAA GIS web site from the Angoon ASOS indicates the wind coverage for any alignment is greater than 99% for ADG II aircraft. Other meteorological conditions are also expected to be equal for the alternatives being evaluated, so this item will not be scored.

Distance from Bird Attractants: The potential for bird and aircraft conflict decrease with increased distance between the airport and bird attractants, such as landfills, wastewater lagoons, and wetlands. The greater the distance allowed between an airport and a bird attractant the better. FAA requires a minimum distance of 5,000 feet for airports serving piston-powered aircraft, 10,000 feet for airports serving turbine aircraft. AC 150/5200-33B Section 1-2 notes that airports that do not sell Jet-A fuel normally serve piston-powered aircraft. For all the concepts on this site, the landfill is within 5,000 feet of the air operations areas. Some difference may exist between the alternatives because of the different runway/approach orientations

Airspace and Land Use Compatibility/Obstructions: Obstructions are objects within areas that are required to be clear for navigation purposes, such as the safety area or the object free zone. In addition, roads should not be allowed within the Runway Protection Zone. Another consideration may also be location of public gathering and fuel storage as related to approaches.

Safe Access: Safe access to the airport involves the ability of the public to travel to and from the airport in inclement weather. Some difference between the alternatives exists depending on the Apron location

Environmental Impacts

Cultural Resources/Subsistence Impacts: The airport site should be chosen to limit impacts on cultural resources and subsistence activities. Cultural resources and subsistence impacts are most likely to occur near the coast.

Floodplain and Watershed (Water Source) Impacts: An ideal airport site would not impact the community water supply or be at risk for flooding.

Stormwater Management: The lower the volume of grubbing waste to dispose of the better for erosion and sediment control.

Land Ownership/Access: A potential site receives a lower score if the land purchase will impact native allotments or a greater number of privately held properties. A higher score is warranted for alternatives that provide opportunity for access to parcels blocked by the airport property and future fencing.

Wetlands/Fish and Wildlife Impacts: The location of the airport development will affect the degree of impact the airport has on wetlands and fish and wildlife. All the alternatives have wetlands and wildlife impacts associated with the runway crossing the creek. For fish habitat considerations, alternatives should minimize the stream modifications and number of culvert crossings.

Quality Design

Geology & Hydrology/Long-Term Stability: An airport site with more favorable geotechnical & hydrological conditions will result in less development and long-term maintenance and operations costs. Favorable geotechnical & hydrological conditions also provide a safer facility because it limits pavement cracking and ground subsidence. Further – culvert crossings are frequently a location where differential settlement can occur. Alternatives should minimize the stream modifications and number of culvert crossings. Higher scores are warranted for alternatives that reduce the risk of settlement and embankment instability.

Maintenance & Operations (M&O) Costs: Ensuring that M&O costs will be reasonable is an important airport development/improvement consideration. M&O costs are affected by the geotechnical conditions at the site.

Construction Costs: The costs of airport construction are affected by the availability of construction materials, surface and subsurface conditions, and the distance from the existing roads and electrical power which affects utility extension and access road construction costs.

Future Expansion Possibilities: An airport site that provides room for future expansion of runways, aprons, and lease lots scores high on this criterion.

APPENDIX C

ALTERNATIVES EVALUATION MATRIX

Scores

The three alternatives scored are Concepts Alpha, Charlie, and Echo (Alts. 1-3)

A score of 1 to 10 is used to rate the alternatives. A higher score indicates a better alternative.

Selection Criteria	Alt. A	Alt. C	Alt. E
<u>Safety</u>			
Approach Capabilities			
Distance from Bird Attractants			
Airspace and Land Use Compatibility/Obstructions			
<u>Environmental Impacts</u>			
Cultural Resources/Subsistence Impacts			
Floodplain and Watershed (Water Source) Impacts			
Land Ownership/Access			
Wetlands/Fish & Wildlife Impacts			
<u>Quality Design</u>			
Geology & Hyrdology/Long-Term Stability			
Maintenance & Operation Costs			
Construction Costs			
Future Expansion Possibilities			
Stormwater Management			

Weighted Scores

This table shows the weighted results of the alternative scoring process. The scoring is on a scale of 1 to 10 scale, with 10 as the best score. The safety, environmental impacts, and quality design score are weighted, the weighting shown is expected to change.

Evaluation Criteria	Weight	Alt. A		Alt. C		Alt. E	
	(%)	Score	(WxS)	Score	(WxS)	Score	(WxS)
<u>Safety</u>	20%						
Approach Capabilities		0.0	0.0	0.0	0.0	0.0	0.0
Distance from Bird Attractants		0.0	0.0	0.0	0.0	0.0	0.0
Airspace and Land Use Compatibility/Obstructions		0.0	0.0	0.0	0.0	0.0	0.0
<i>Safety Total Score</i>			0.0		0.0		0.0
<u>Environmental Impacts</u>	20%						
Cultural Resources/Subsistence Impacts		0.0	0.0	0.0	0.0	0.0	0.0
Floodplain and Watershed (Water Source) Impacts		0.0	0.0	0.0	0.0	0.0	0.0
Land Ownership/Access		0.0	0.0	0.0	0.0	0.0	0.0
Wetlands/Fish & Wildlife Impacts		0.0	0.0	0.0	0.0	0.0	0.0
<i>Environmental Impacts Total Score</i>			0.0		0.0		0.0
<u>Quality Design</u>	60%						
Geology & Hydrology/Long-Term Stability		0.0	0.0	0.0	0.0	0.0	0.0
Maintenance & Operation Costs		0.0	0.0	0.0	0.0	0.0	0.0
Construction Costs		0.0	0.0	0.0	0.0	0.0	0.0
Future Expansion Possibilities		0.0	0.0	0.0	0.0	0.0	0.0
<i>Quality Design Total Score</i>			0.0		0.0		0.0
Safety Total Score	20%	0.0	0.0	0.0	0.0	0.0	0.0
Environmental Impacts Total Score	20%	0.0	0.0	0.0	0.0	0.0	0.0
Quality Design Total Score	60%	0.0	0.0	0.0	0.0	0.0	0.0
Stormwater Management		0.0	0.0	0.0	0.0	0.0	0.0
Total Score			0.0		0.0		0.0



APPENDIX D

HYDROLOGIC AND HYDRAULIC CONSIDERATIONS

Memo

Date: Monday, December 04, 2017

Project: Angoon Airport

To: Mark Dalton, HDR; Royce Conlon, Angela Smith, Ken Risse, PDC

From: Dan Billman, Kyle Walker

Subject: Angoon Airport Runway Alternatives A–E Comments

Alignment Alternatives

PDC has developed five concept runway and apron alternatives: Alpha, Bravo, Charlie, Delta, and Echo (alternatives A, B, C, D, and E), which represent a range of alignments and apron locations. The plan, cross section, and profile information dated 17y09m12d is located on the Basecamp collaborative website and was used for this review. Ken Risse of PDC was also contacted for an explanation of how to interpret the information on the drawings and the runway concept represented by each alternative. We also understand that the present goal is to gather comments and insights into the constraints and opportunities of each alternative.

These review comments pertain primarily to drainage issues and are presented to identify any “fatal flaws” with an alternative, or any component of an alternative, that may make it extremely expensive or infeasible to construct. This review also provides observations on other features of the alternatives for consideration in the elimination of some options from further development to address in a more detailed analysis.

In general, runway alignment alternatives A, B, and E are placed on the higher, and dryer, ground south of the two creek forks and associated bog. These runway alignments pose no drainage fatal flaws. Alignment alternatives C and D place the runway over parts of the north and south creek forks, which presents major drainage design issues and greater wetland impacts.

The north apron location for alternative E, which can be placed on the quarried hill, presents the best apron location of all the alternatives. This option has the fewest potential drainage issues with straightforward drainage design. This apron location can be also used for runway alignment alternatives A and B if a longer, uphill taxiway is used.

The apron location for alternative A, which covers the north creek fork, will require an extensive creek reroute, ditching around the apron, and a culvert under the taxiway. Although not fatal flaws, the drainage components will require careful design, and construction will be expensive.

The south apron locations shown on alternatives B, C, and D may have fatal flaws. These apron locations are east of the runway and will require major excavation (40 feet or more) on their eastern sides because the terrain slopes up quickly in that direction from the runway. All of the locations will impact the south creek fork channel and will have extensive drainage issues. These apron locations will have major constructability issues from a drainage perspective.

These points are discussed in more detail below. Runway plan figures with comments are attached.

Alternatives A and B

Alternatives A and B have the same runway alignment, but shift the location south in alternative A and north in alternative B. Both cross the creek in a good location and will require a 300-foot-long culvert for the creek. There appears to be sufficient fill depth to install the required culvert, which is estimated to be a 6-foot-high by 6- to 10-foot-wide concrete box culvert. Drainage on the west side of the culvert will be sheet flow off the runway fill into the vegetation at the fill toe. No drainage ditches are needed.

Drainage off the east side of the runway fill will flow either to the fill toe and then into the vegetation or to the east edge of the primary surface cut where a ditch will be constructed to carry the flow south along the runway slope to vegetated areas.

Both alternatives locate the runway outside of the two creek forks and place the culvert under the runway, downstream of the confluence of the two forks. This is the ideal location, as it maintains the two forks and their function of capturing and channeling the bog discharge. This function is very important in controlling groundwater flow and would be extremely difficult to replicate through ditch construction.

The south end of alternative A ends at a large ravine, STA 46+50, and fills the ravine. This ravine is a natural drainage path and, if the runway is moved north, the ravine would be left unfilled and the drainage from the east side of the runway could be directed to the ravine and flow away from the site.

Alternative B extends farther north and will require a large fill in a bog at the north end of the runway. The fill may impact drainage paths in the bog, which in turn may change flow into the salt chuck to the north. Depending on the nature of the flow path changes and the water quality of the drainage, the drainage pattern changes may have negative impacts on the salt chuck.

Both alternatives have the apron located either in or partially in the bog east of the runway. Alternative A places the apron in the bog on top of the north creek fork. If the apron is located here, the creek must be rerouted in a ditch. Because there is deep peat in the bog and the creek channel bottom is peat, construction of a stable channel will require that the peat be excavated from under the channel location, the location back-filled, and the creek built in the fill, all which increase cost and wetland impacts. The channel will be 500 to 600 feet long.

Alternative B places the apron in the south creek fork and bog. This location will require that the apron be cut into the terrain. The back slope into the bog will intersect the creek and will be unstable, saturated, unconsolidated peat. Drainage management will require ditches to capture the discharge from the bog cut-slope. If the apron is located here, the creek must be rerouted in a ditch. Because there is deep peat in the bog, construction of a stable channel will require that the peat be excavated from under the channel location, the location back-filled, and the creek built in the fill, which increases cost and wetland impacts. Finally, a culvert will be required under the taxiway at the east edge of the primary surface cut to convey drainage from north to south at the cut edge.

Alternative B will also place fill in the bog at the north end of the runway. The fill may impact bog drainage patterns, which may reroute drainage into the salt chuck. The increased water flow, especially if it contains sediment, can degrade the water quality of the salt chuck habitat and should be evaluated.

Alternatives C and D

Alternatives C and D twist the north end of the runway east. Moving the runway in this direction places it over long segments of the north and south creek channel and in the bog. Constructing the runway here will require extensive construction of new creek channels. Because there is deep peat in the bog, construction of a stable channel will require that the peat be excavated from under the channel location,

the location back-filled, and the creek built in the fill. This increases cost and wetland impacts and represents the least desirable location for the runway in regard to creek impacts.

Alternative C has two apron locations. One location places the apron on top of the south creek fork and bog. This location will require that the apron be cut into the bog and the creek rerouted. The back slopes into the bog will be unstable, saturated, unconsolidated peat. Drainage management will require ditches to capture the discharge from the bog cut-slope and to reroute the creek. Because there is deep peat in the bog, construction of a stable channel will require that the peat be excavated from under the channel location, the location be back-filled, and the creek built in the fill. Also, the east cut-slope for the apron will intersect the south creek at an elevation of approximately 140 feet, while the apron will be at an elevation of about 100 feet, creating a 40-foot drop in the creek. To then reroute the creek from the east side of the apron to the runway will require construction of a ditch below the apron level (elevation of about 100 feet) and make the creek bottom elevation about 95 feet. A channel with a nominal 0.5 percent slope will require a culvert under the taxiway, and channel construction—about 1,600–1,800 feet—will extend to or beyond the creek channel under the runway. This increases cost and wetland impacts, and represents the least desirable location for the apron in regard to creek impacts. Finally the east cut slopes will likely intersect the road to the water treatment plant and tank, requiring it to be relocated.

A culvert is required under the taxiway for the apron at the east edge of the runway fill toe to convey drainage from south to north and into the creek.

The second apron location places the apron on the west side of the north end of the runway. The location requires that the north side of the apron be cut into a hill and the west side be placed on a fill pad. The configuration of the apron and taxiway will create an area will drainage can on and require a culvert under the taxiway.

Alternative D places the apron in the hill and under the road at the south end of the runway. This location will require that the apron be cut into the hill bog and the creek rerouted. The back slopes into the bog will be unstable, saturated, unconsolidated peat and be about 40 feet tall. The apron will likely intersect the south creek fork. A culvert will be required under the taxiway at the east edge of the primary surface cut to convey drainage from north to south at the cut edge.

The road reroute for the alternative D apron location will require crossing the south creek fork upstream of the current crossing. Crossing this creek upstream of the existing culvert will move the road into a bog that will require additional creek culverts and excavation of the peat to construct the road.

Alternative E

The alternative E runway alignment is similar to the alignment for alternatives A and B, with the north end shifted slightly east. The runway, like under alternatives A and B, sits atop the high ground west of the two creek forks and the associated bog. The runway crosses the main creek channel downstream of the forks' confluence and will require a slightly longer culvert because of the greater skew crossing angle, approximately 350 feet, versus 300 feet for Alternatives A and B. This is the ideal location, as it maintains the two forks and their function of capturing and channeling the bog discharge. This function is important in controlling groundwater flow and would be extremely difficult to replicate through ditch construction.

Alternative E will also place fill in the bog at the north end of the runway, although higher in the bog watershed than alternative B. The fill may impact bog drainage patterns, which may reroute drainage into the salt chuck. The increased water flow, especially if it contains sediment, can degrade the water quality of the salt chuck habitat and should be evaluated.

Two alternative locations for the apron are shown in the attached figures. The south option is the same as alternative B and has the same drainage issues noted above. From a drainage perspective, this is the least desirable location for the apron.

The north apron alternative places the apron over the hill at the north end of the runway. Assuming that the hill is a quarry source for the runway fill, it could be excavated to an elevation of about 125 feet and match the runway elevation at the taxiway. Drainage off the quarry-apron can be addressed by constructing the apron and quarry area to discharge to the surrounding vegetation at multiple points and dispersing the drainage into the natural vegetation, minimizing potential impacts. This apron alternative also allows for construction of the access road to the apron at the divide between the salt chuck and south creek fork drainage basins, minimizing impacts to both basins and reducing the need for drainage structures.

From a drainage perspective, the ideal location for alternative E with the fewest impacts is to place the apron on the excavated hill. For this reason, a similar apron alternative has been shown on runway alignment alternative A. Runway alternative A is at a lower elevation than alternative E and the apron location for alternative A will require either a longer taxiway that is constructed at a 2 percent slope, or removal of the hill to an elevation lower than 125 feet.

DRAFT

LAYOUT CONCEPT - ALFA

SCALE: 1" = 1000'

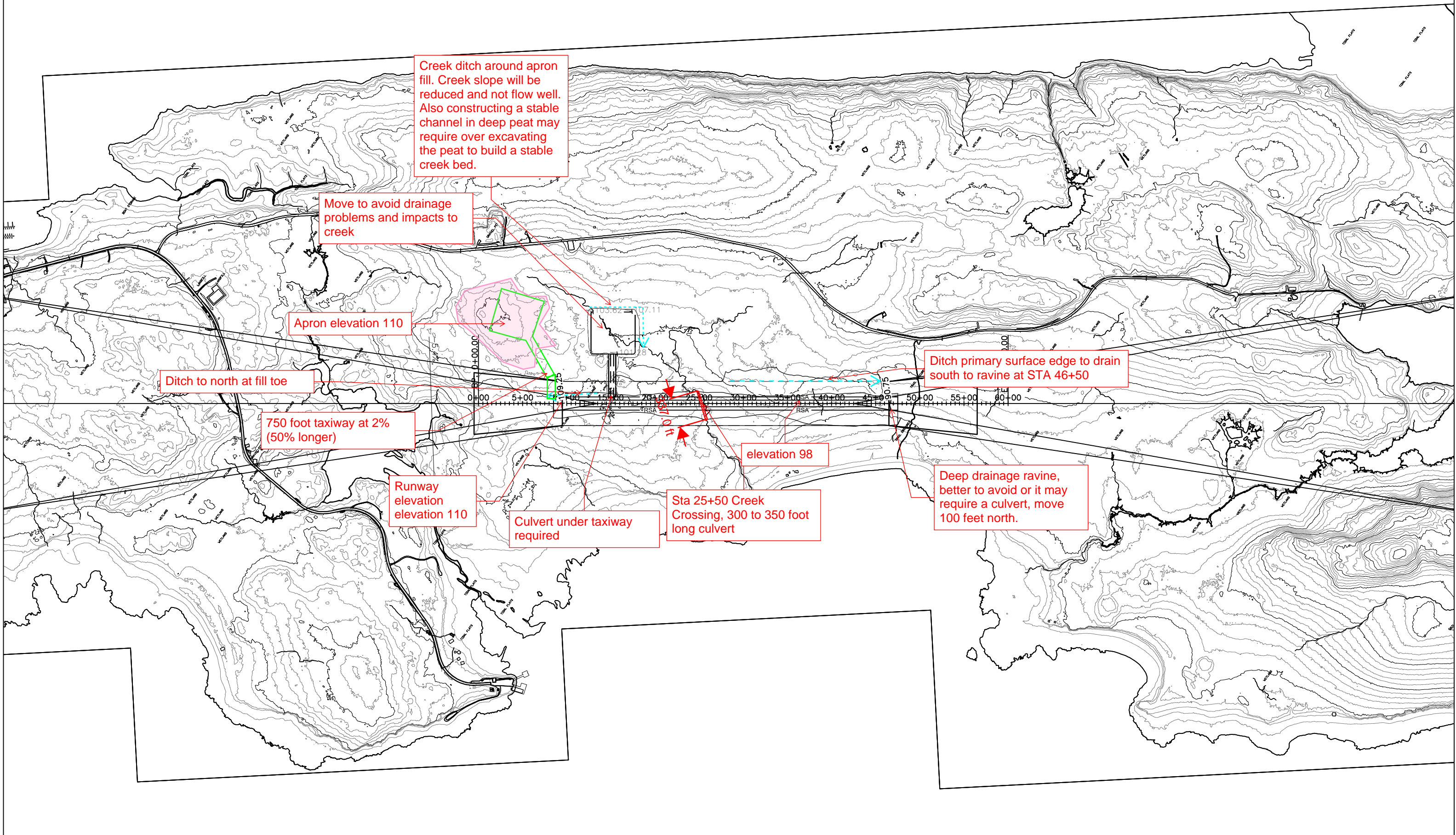
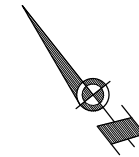

LAYOUT CONCEPT - BRAVO

SCALE: 1" = 1000'

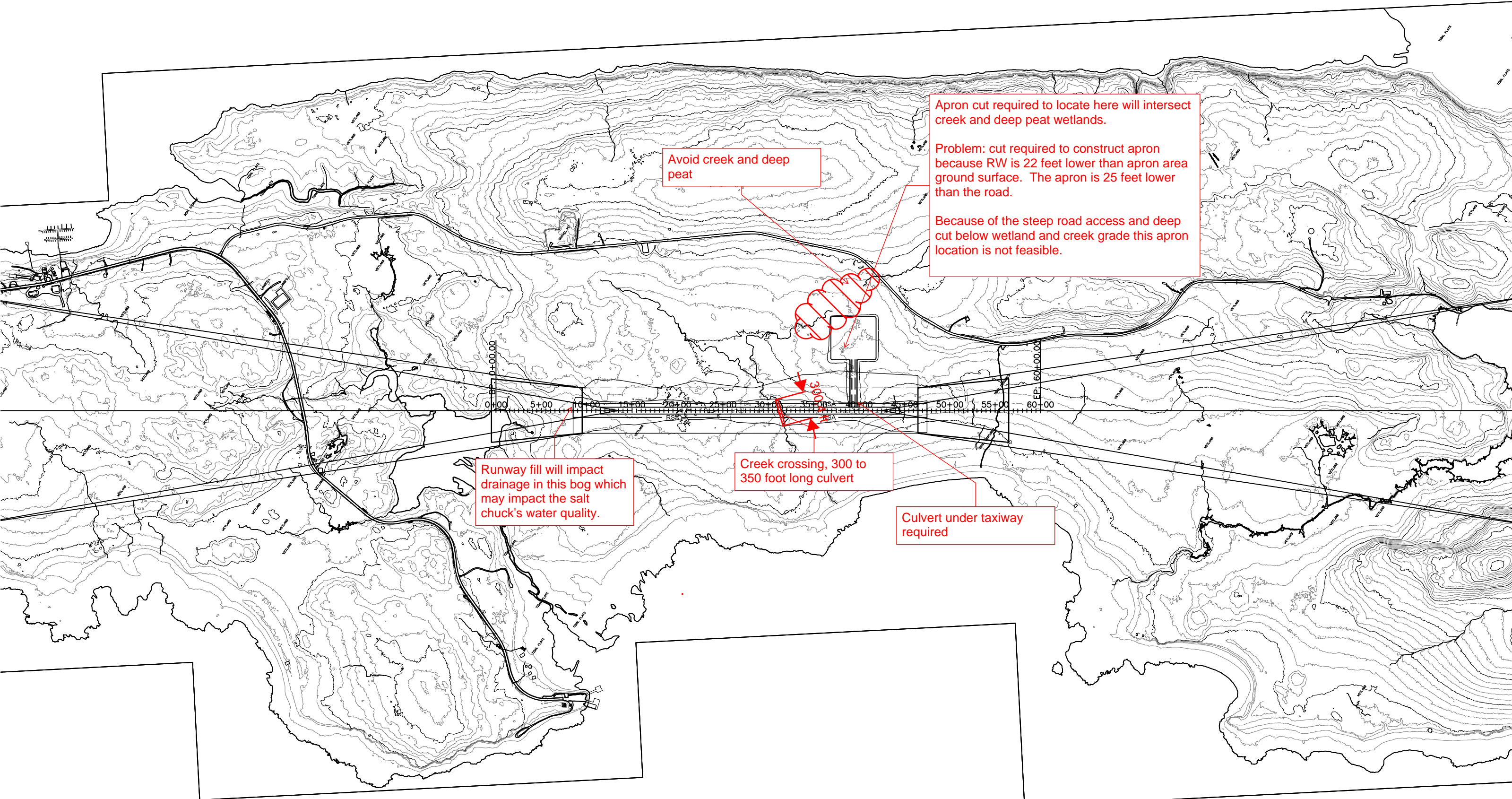
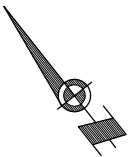

Avoid creek and deep peat

Apron cut required to locate here will intersect creek and deep peat wetlands.

Problem: cut required to construct apron because RW is 22 feet lower than apron area ground surface. The apron is 25 feet lower than the road.

Because of the steep road access and deep cut below wetland and creek grade this apron location is not feasible.

Runway fill will impact drainage in this bog which may impact the salt chuck's water quality.

Creek crossing, 300 to 350 foot long culvert

Culvert under taxiway required

LAYOUT CONCEPT - CHARLIE

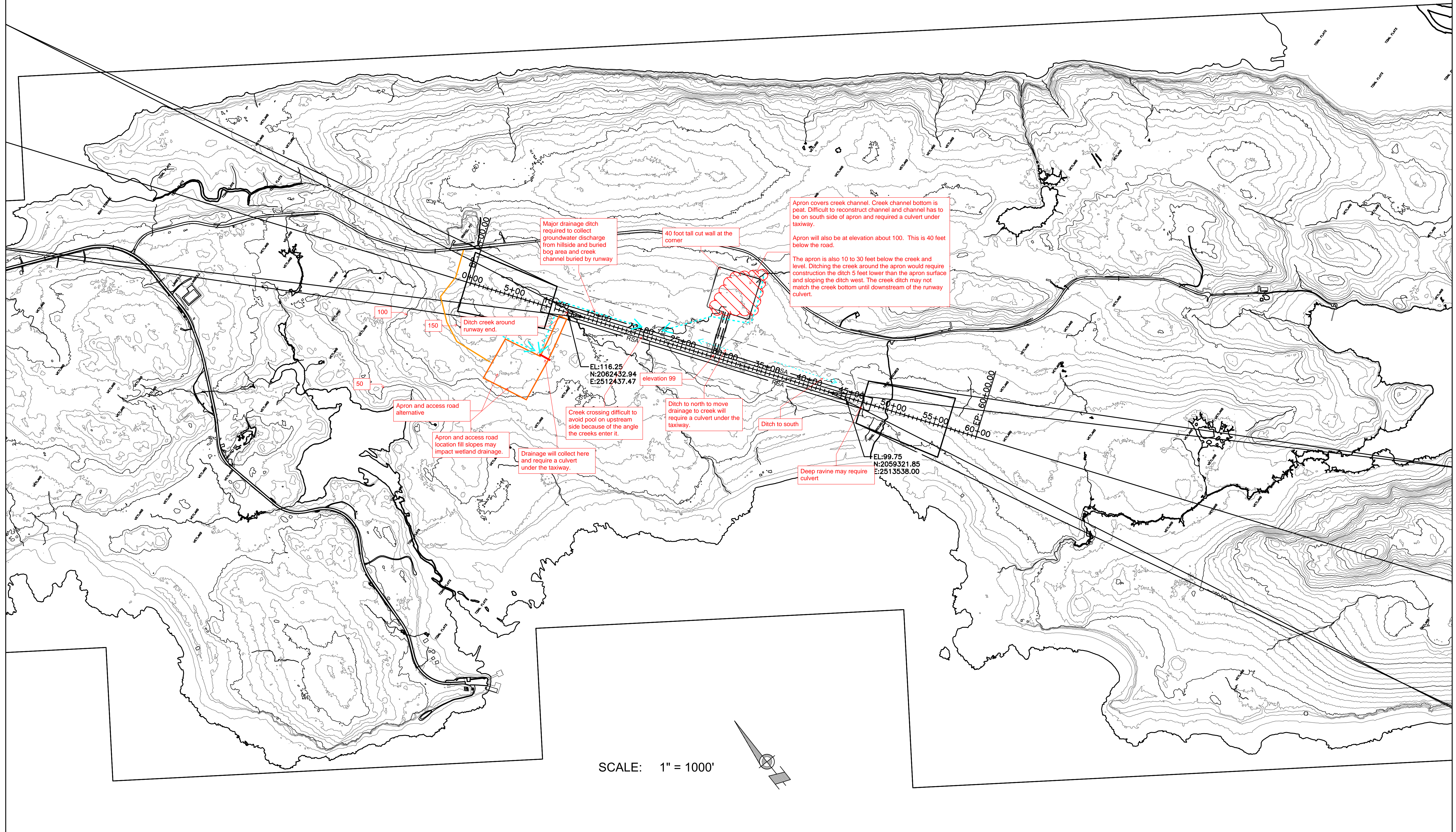

LAYOUT CONCEPT - DELTA

SCALE: 1" = 1000'

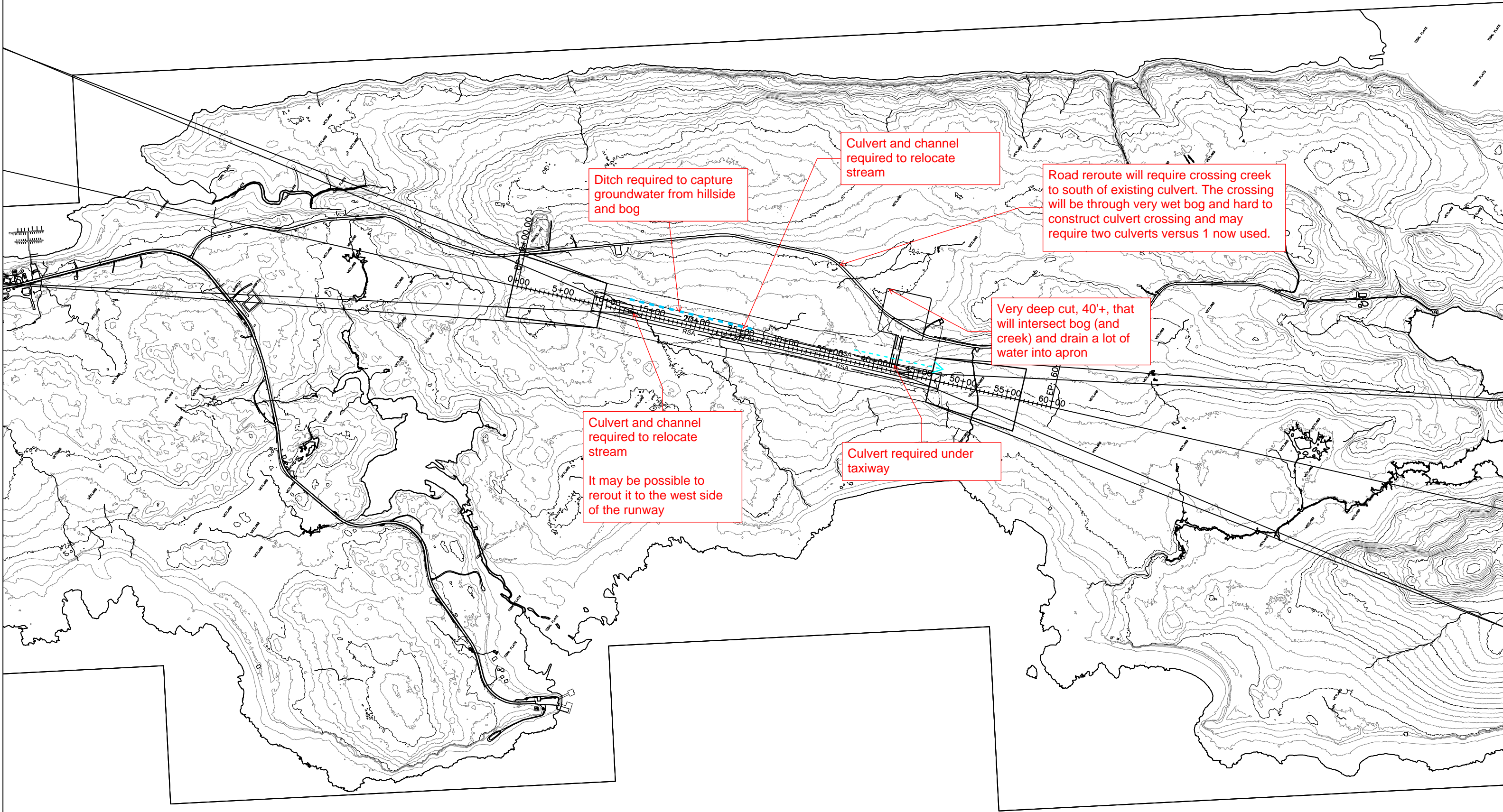
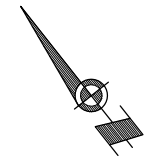

Ditch required to capture groundwater from hillside and bog

Culvert and channel required to relocate stream

Road reroute will require crossing creek to south of existing culvert. The crossing will be through very wet bog and hard to construct culvert crossing and may require two culverts versus 1 now used.

Very deep cut, 40'+, that will intersect bog (and creek) and drain a lot of water into apron

Culvert and channel required to relocate stream

It may be possible to rerout it to the west side of the runway

Culvert required under taxiway

LAYOUT CONCEPT - ECHO

SCALE: 1" = 1000'

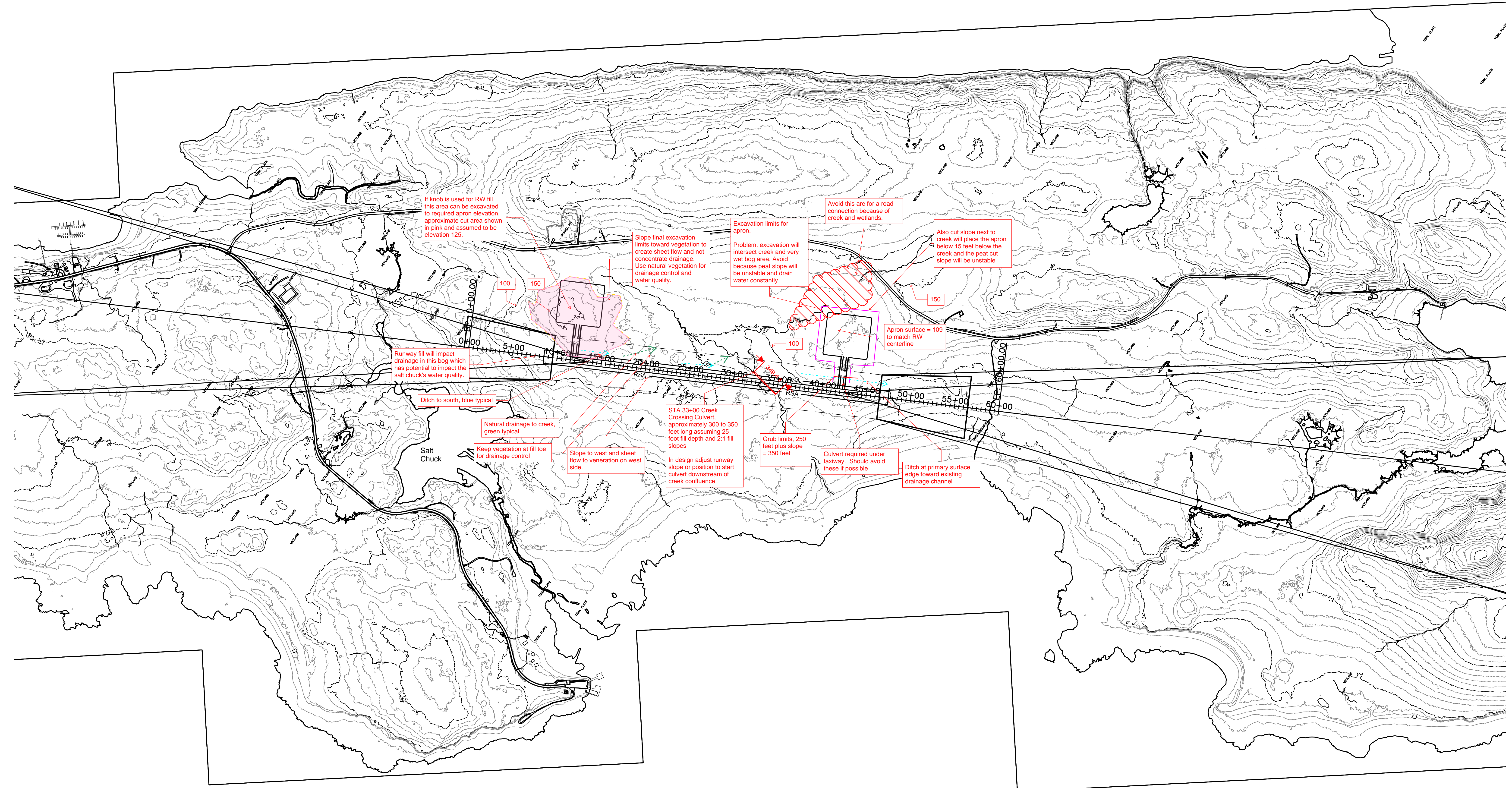
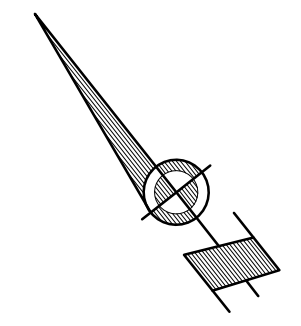



APPENDIX E

ALTERNATIVES

OVERALL

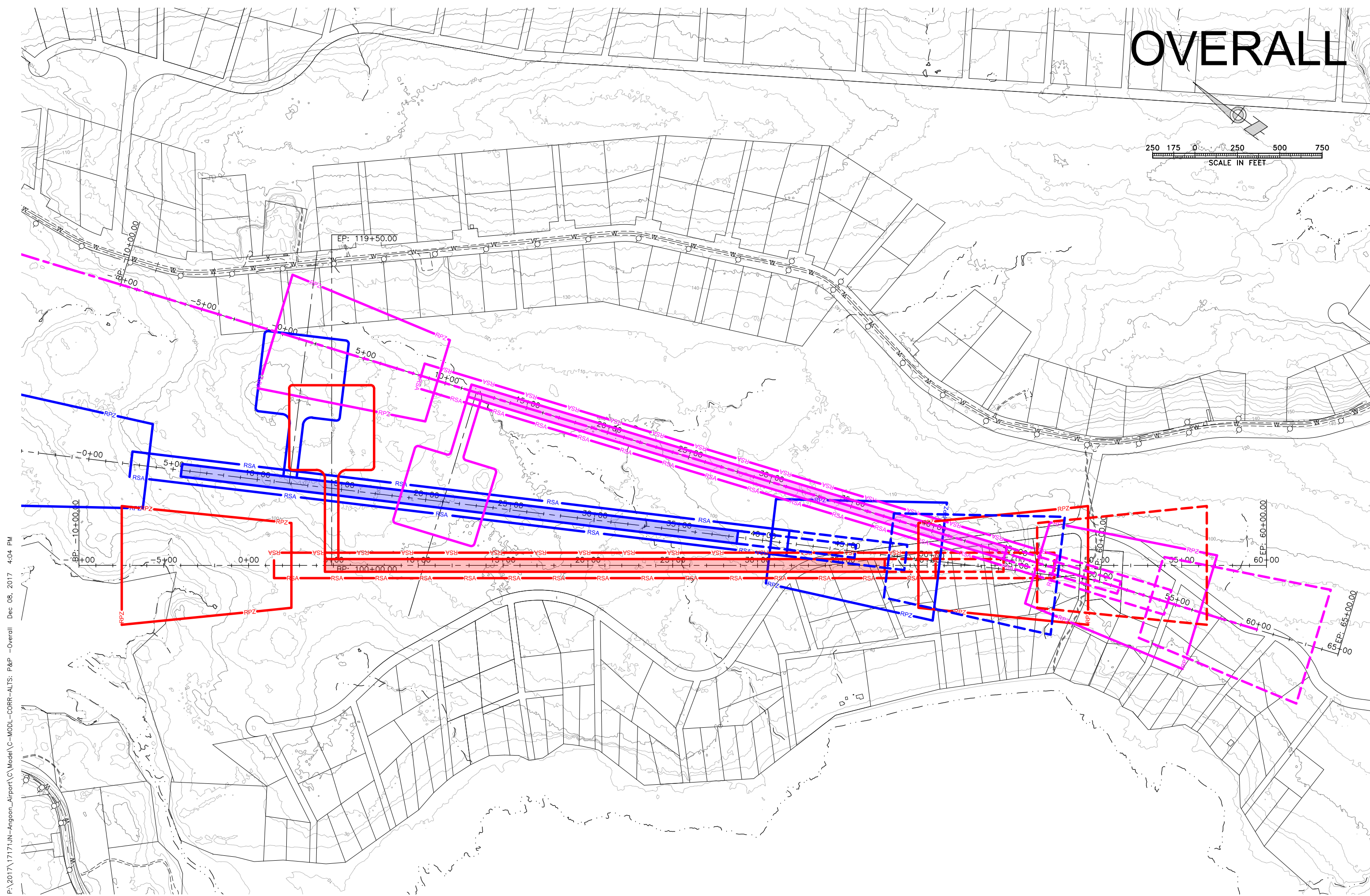
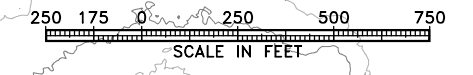

ALPHA

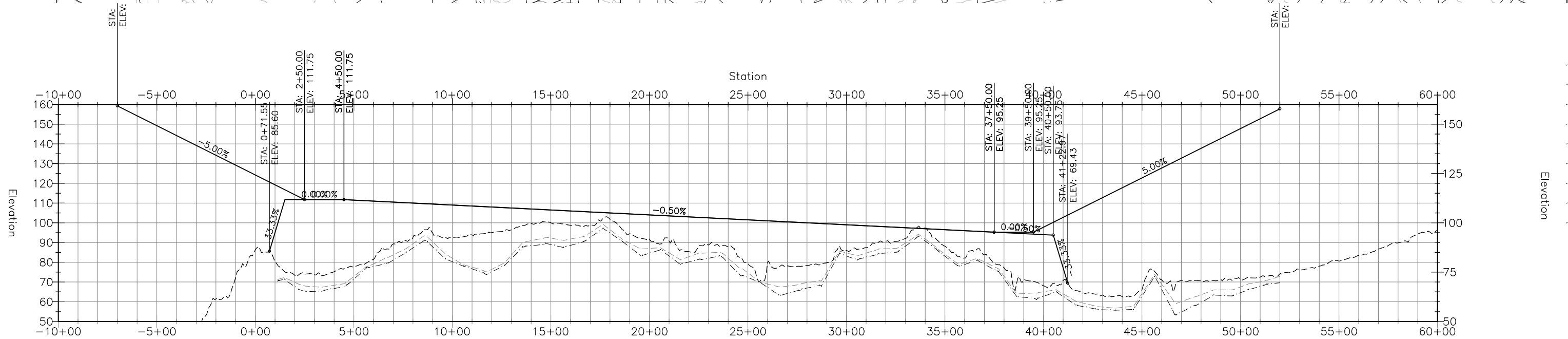
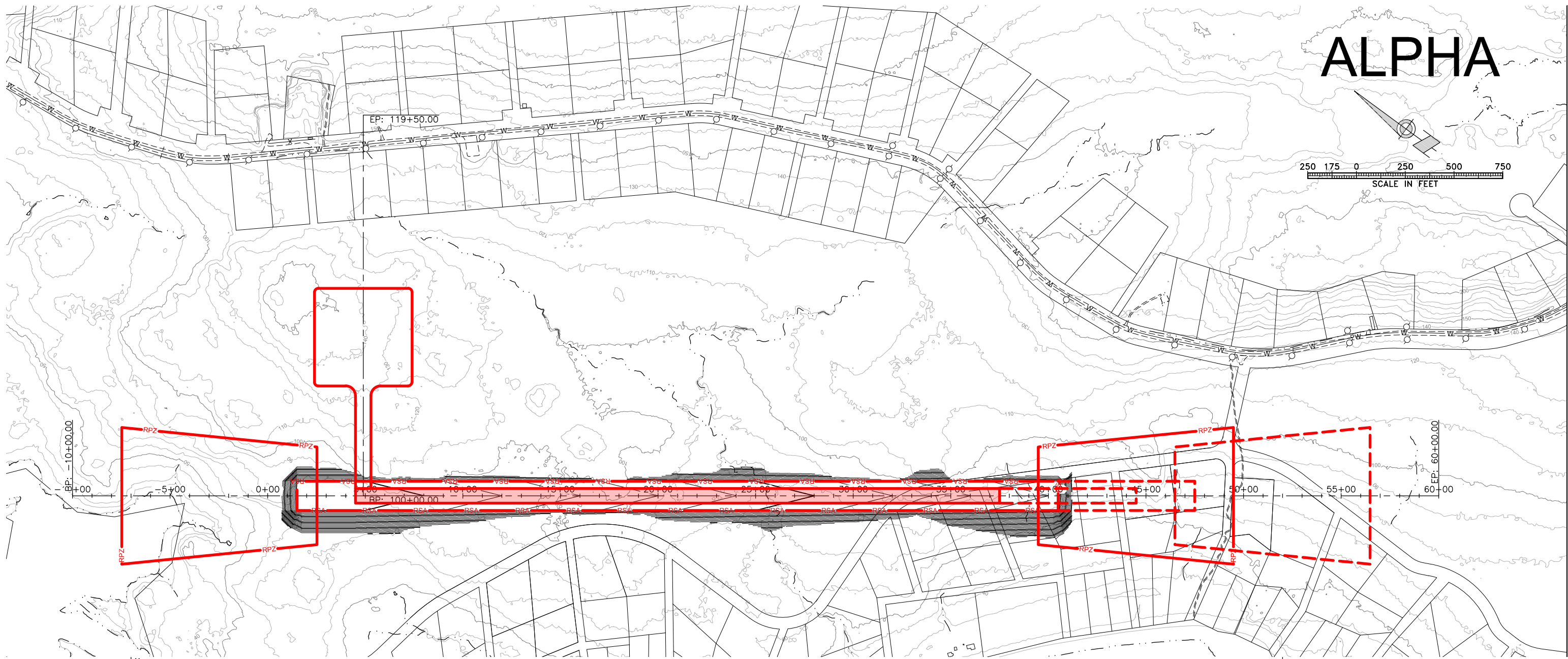
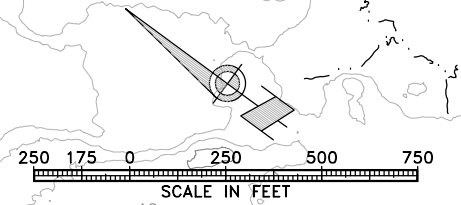

ALPHA

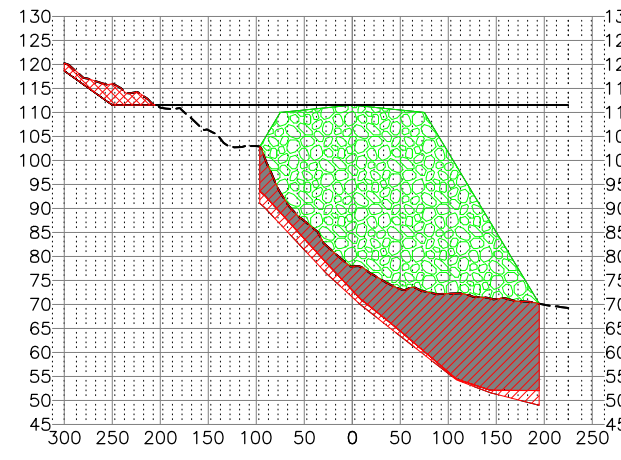

5+00

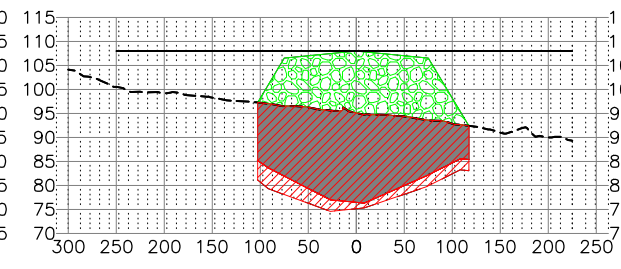

12+00

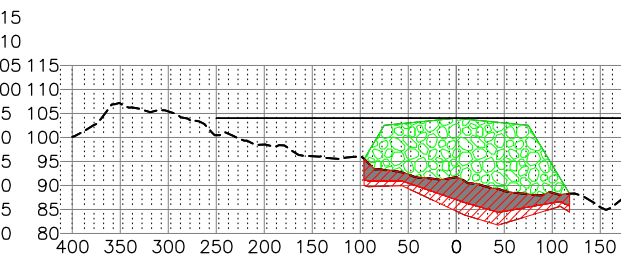

20+00

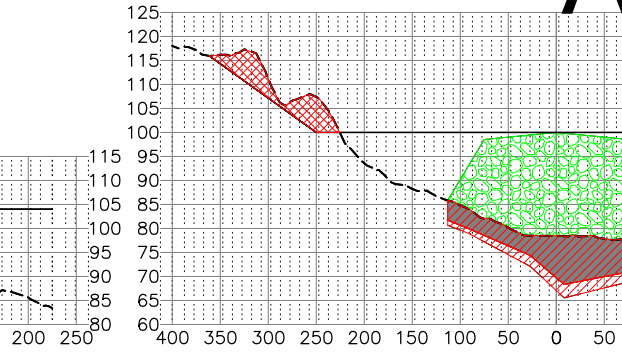

28+00

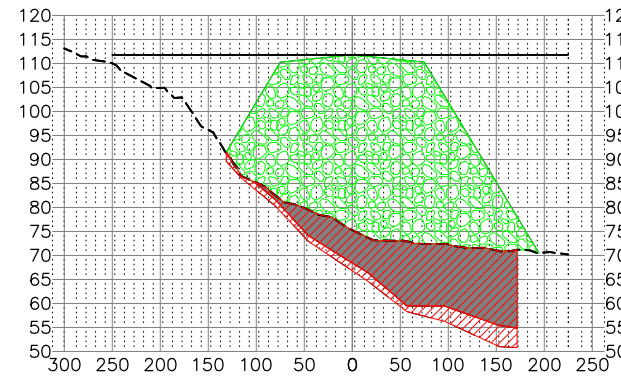

4+00

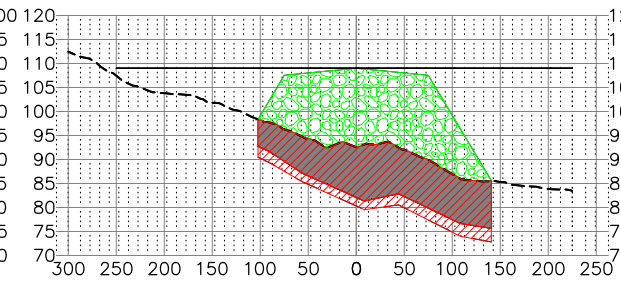

10+00

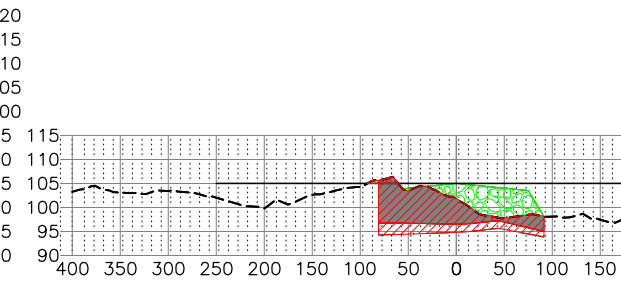

18+00

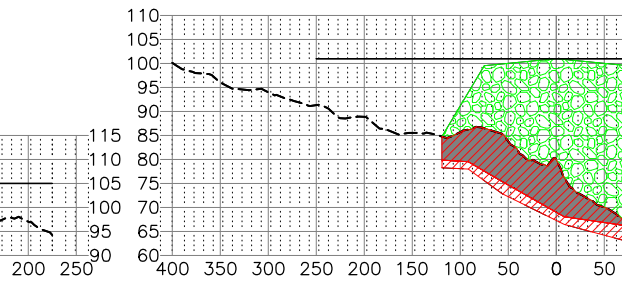

26+00

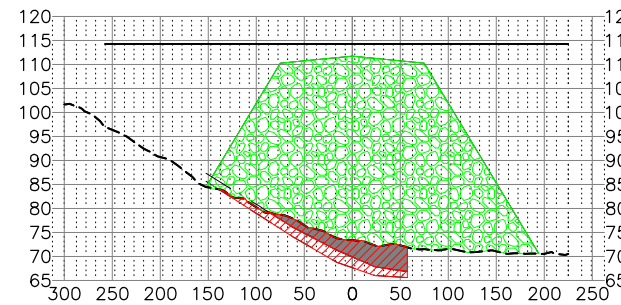

2+00

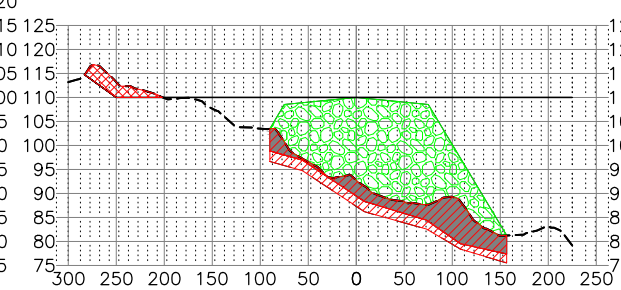

8+00

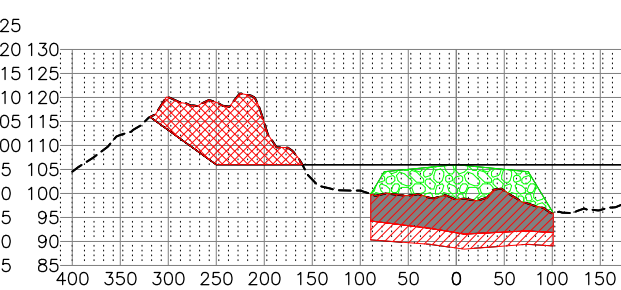

16+00

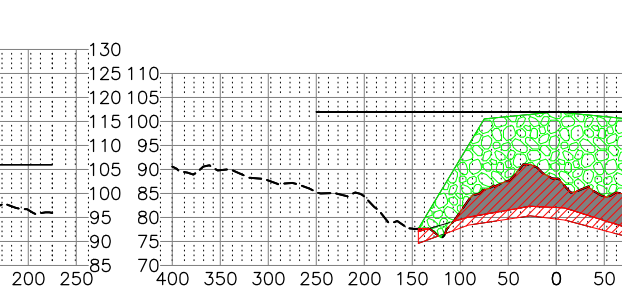

24+00

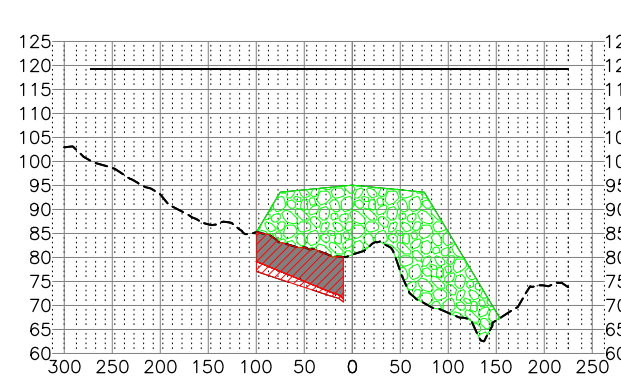

1+00

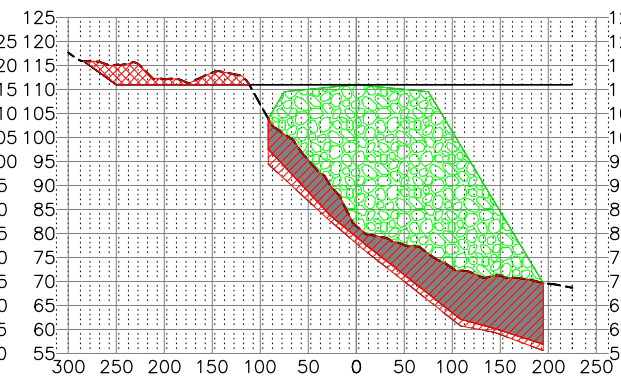

6+00

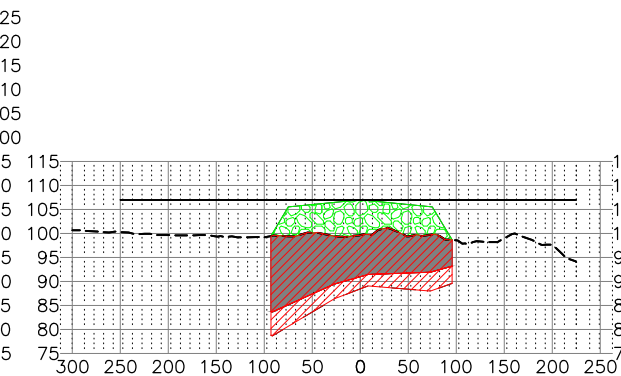

14+00

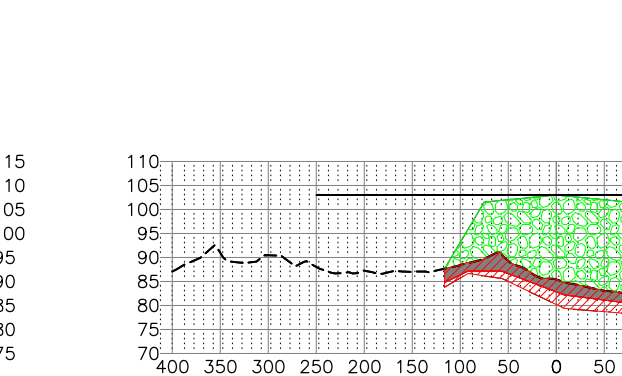

22+00

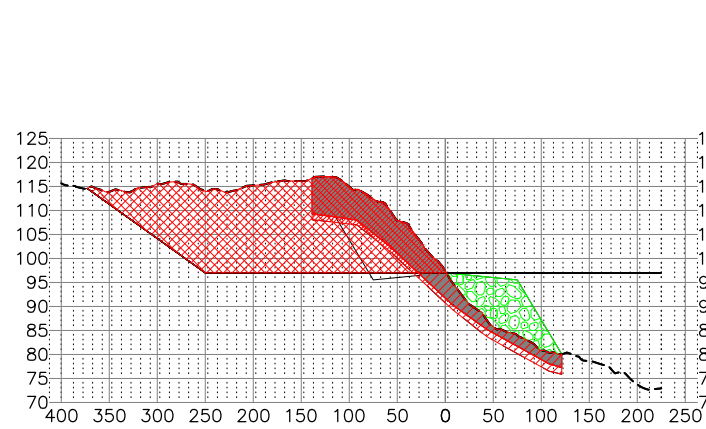

34+00

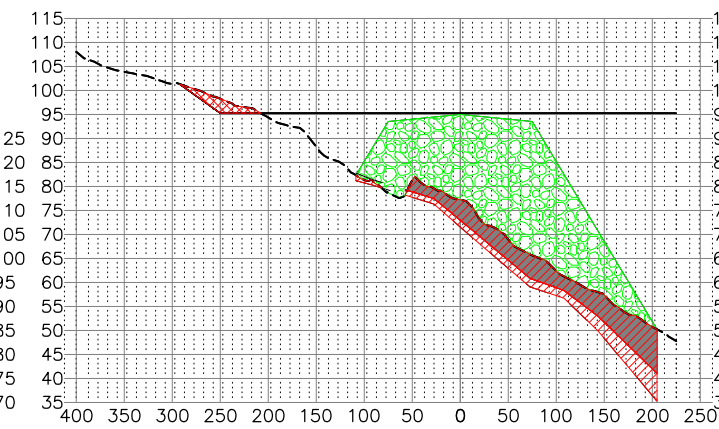

38+00

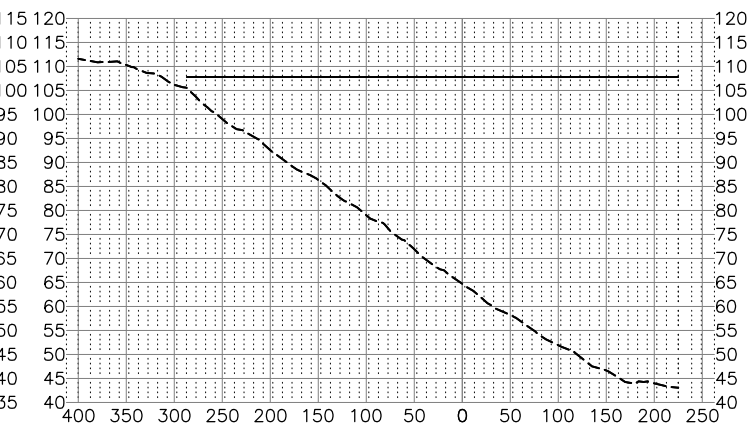

42+00

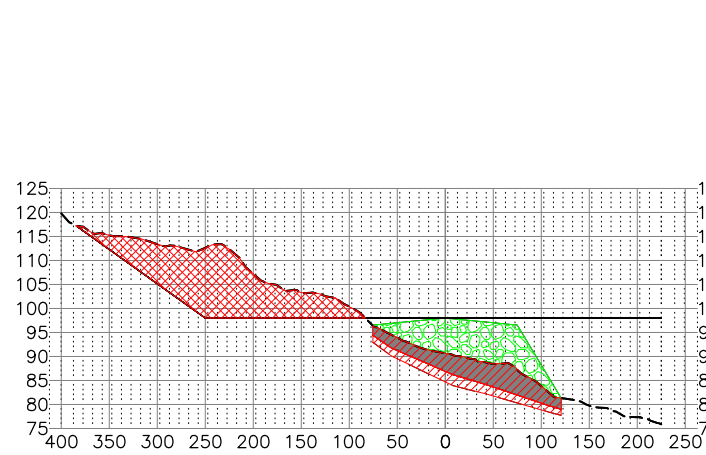

32+00

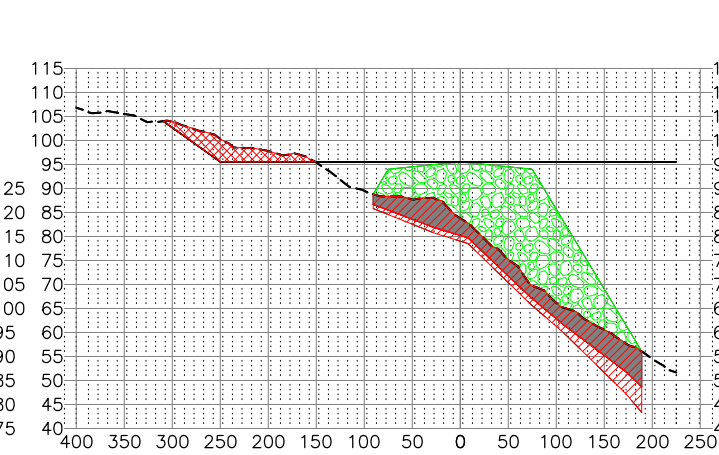

37+00

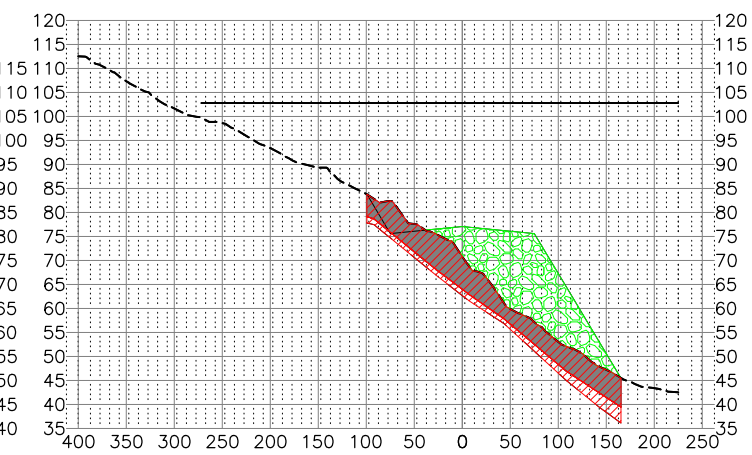

41+00

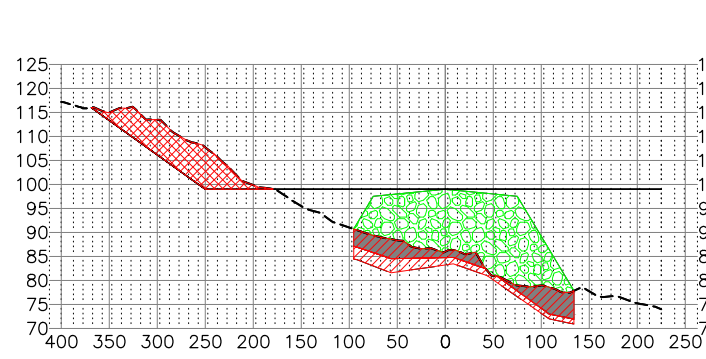

30+00

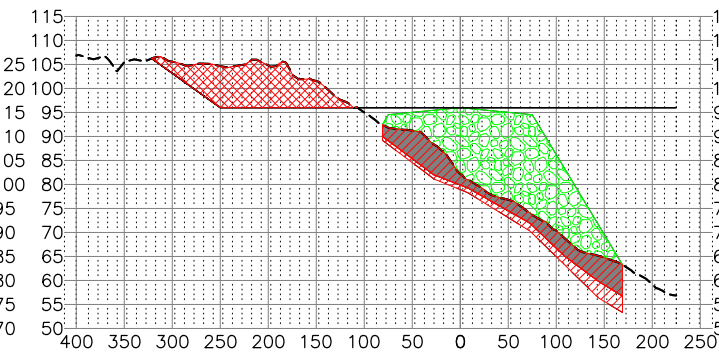

36+00

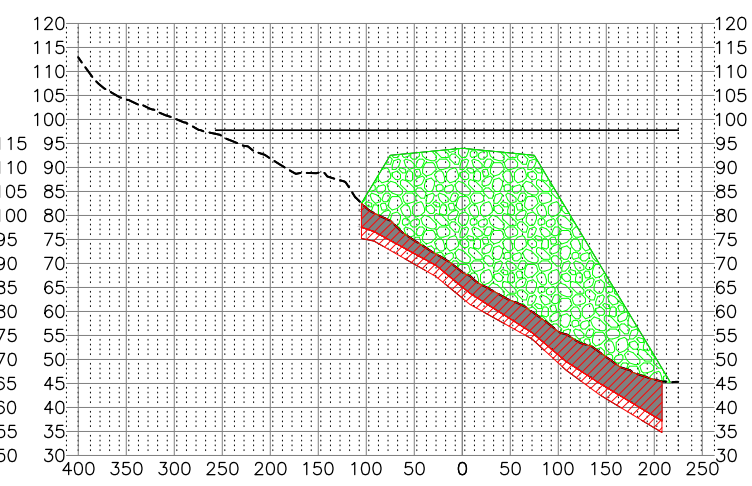

40+00

ALPHA

ALPHA

MATERIAL TABLE Peat Removal Only			
STATION	AREA	VOLUME	CUMULATIVE VOLUME
1+00.00	627.90	0.00	0.00
2+00.00	429.00	1957.23	1957.23
4+00.00	2548.28	11026.99	12984.22
5+00.00	3172.20	10593.49	23577.71
6+00.00	2209.48	9966.08	33543.79
8+00.00	825.54	11240.83	44784.61
10+00.00	2217.25	11269.61	56054.22
12+00.00	3219.85	20137.41	76191.63
14+00.00	1889.46	18923.35	95114.98
16+00.00	1253.35	11640.01	106754.99
18+00.00	813.14	7653.67	114408.66
20+00.00	657.05	5445.17	119853.83
22+00.00	702.79	5036.43	124890.27
24+00.00	1335.85	7550.50	132440.77
26+00.00	1327.57	9864.54	142305.31
28+00.00	1526.23	10569.66	152874.97
30+00.00	611.69	7918.25	160793.23
32+00.00	727.50	4959.99	165753.22
34+00.00	1308.82	7541.95	173295.16
36+00.00	936.58	8316.30	181611.47
37+00.00	1166.11	3893.87	185505.33
38+00.00	1169.40	4325.03	189830.36
40+00.00	1428.42	9621.59	199451.95
41+00.00	1461.39	5351.52	204803.46
42+00.00	0.00	2706.29	207509.75

MATERIAL TABLE Removal to Refusal			
STATION	AREA	VOLUME	CUMULATIVE VOLUME
1+00.00	749.68	0.00	0.00
2+00.00	768.31	2811.09	2811.09
4+00.00	3186.29	14646.64	17457.72
5+00.00	3584.11	12537.77	29995.50
6+00.00	2631.11	11509.67	41505.17
8+00.00	1296.33	14546.11	56051.27
10+00.00	2752.15	14994.40	71045.68
12+00.00	3753.54	24095.16	95140.83
14+00.00	2543.66	23322.96	118463.79
16+00.00	1864.01	16324.70	134788.50
18+00.00	1125.64	11072.79	145861.29
20+00.00	1037.52	8011.70	153872.99
22+00.00	1167.70	8167.48	162040.47
24+00.00	1844.50	11156.31	173196.78
26+00.00	1904.30	13884.43	187081.21
28+00.00	2085.24	14776.05	201857.26
30+00.00	1006.24	11449.92	213307.18
32+00.00	1084.89	7744.92	221052.11
34+00.00	1624.25	10033.85	231085.96
36+00.00	1339.50	10976.84	242062.80
37+00.00	1698.04	5625.07	247687.87
38+00.00	1792.51	6463.98	254151.86
40+00.00	2076.56	14329.89	268481.74
41+00.00	1888.15	7342.06	275823.80
42+00.00	0.00	3496.58	279320.38

MATERIAL TABLE P77 Cut			
STATION	AREA	VOLUME	CUMULATIVE VOLUME
1+00.00	0.00	0.00	0.00
2+00.00	0.00	0.00	0.00
4+00.00	0.00	0.00	0.00
5+00.00	224.50	415.75	415.75
6+00.00	367.10	1095.57	1511.31
8+00.00	182.07	2033.98	3545.29
10+00.00	0.00	674.34	4219.63
12+00.00	0.00	0.00	4219.63
14+00.00	0.00	0.00	4219.63
16+00.00	1333.58	4939.17	9158.80
18+00.00	23.28	5025.40	14184.20
20+00.00	0.00	86.23	14270.43
22+00.00	0.00	0.00	14270.43
24+00.00	0.00	0.00	14270.43
26+00.00	0.00	0.00	14270.43
28+00.00	558.98	2070.29	16340.72
30+00.00	890.56	5368.68	21709.40
32+00.00	2141.76	11230.82	32940.22
34+00.00	4971.27	26344.53	59284.76
36+00.00	1232.84	22978.16	82262.91
37+00.00	391.26	3007.59	85270.51
38+00.00	129.44	964.27	86234.77
40+00.00	0.00	479.41	86714.18
41+00.00	0.00	0.00	86714.18
42+00.00	0.00	0.00	86714.18

MATERIAL TABLE Fill to OG			
STATION	AREA	VOLUME	CUMULATIVE VOLUME
1+00.00	3320.75	0.00	0.00
2+00.00	9074.43	22954.04	22954.04
4+00.00	8346.78	64522.97	87477.01
5+00.00	7034.76	28484.33	115961.34
6+00.00	5954.08	24053.41	140014.75
8+00.00	3342.47	34431.64	174446.39
10+00.00	3063.83	23727.04	198173.43
12+00.00	2218.70	19564.93	217738.36
14+00.00	1073.32	12192.66	229931.02
16+00.00	999.14	7675.78	237606.80
18+00.00	505.90	5574.22	243181.03
20+00.00	2289.67	10353.95	253534.97
22+00.00	3272.24	20599.65	274134.62
24+00.00	3249.73	24155.46	298290.08
26+00.00	5452.57	32230.76	330520.84
28+00.00	4138.25	35521.55	366042.39
30+00.00	2559.14	24805.15	390847.54
32+00.00	1147.89	13729.75	404577.30
34+00.00	837.89	7354.75	411932.04
36+00.00	2844.16	13637.22	425569.27
37+00.00	3317.35	11410.20	436979.46
38+00.00	4936.87	15285.59	452265.06
40+00.00	6424.76	42080.13	494345.19
41+00.00	1941.54	15493.16	509838.35
42+00.00	0.00	3595.45	513433.81

Surface Properties - Alpha P77 Removal Vol

Information | Definition | Analysis | Statistics

Statistics	Value
General	
TIN	
Volume	
Base Surface	Angoon EG Surface
Comparison Surface	P77-Alpha Surface
Cut Factor	1.00
Fill Factor	1.00
Cut volume (adjusted)	79018.65 Cu. Yd.
Fill volume (adjusted)	4231037.86 Cu. Yd.
Net volume (adjusted)	4152019.21 Cu. Yd. <Fill>
Cut volume (unadjusted)	79018.65 Cu. Yd.
Fill volume (unadjusted)	4231037.86 Cu. Yd.
Net volume (unadjusted)	4152019.21 Cu. Yd. <Fill>

CHARLIE

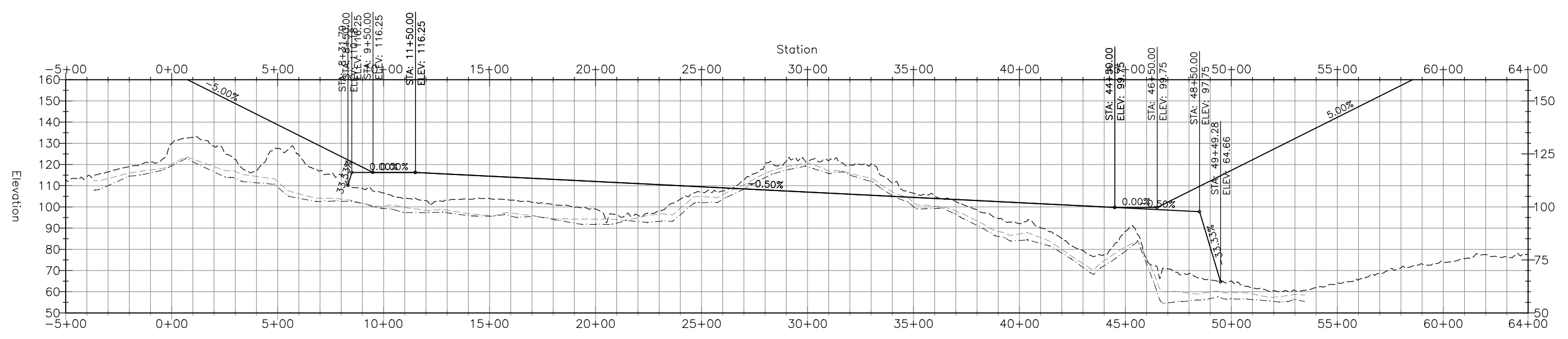
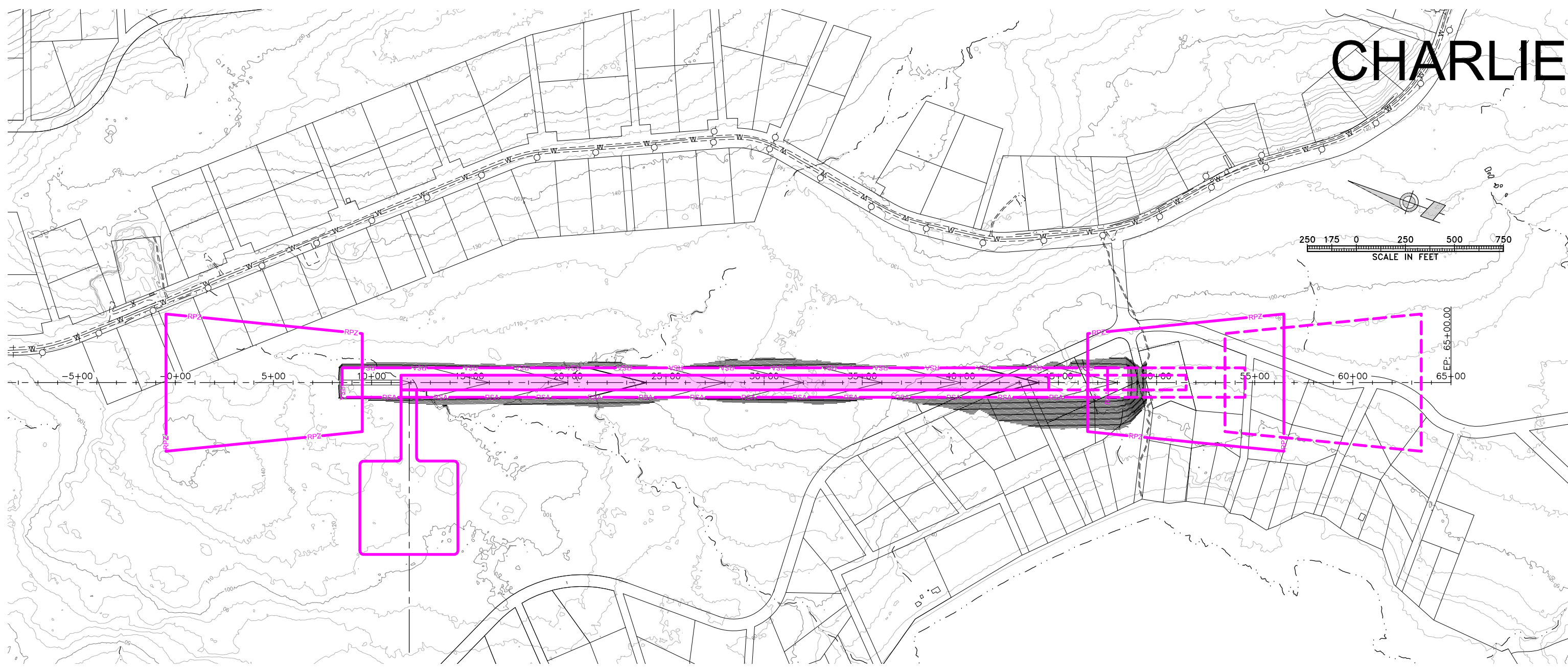

CHARLIE

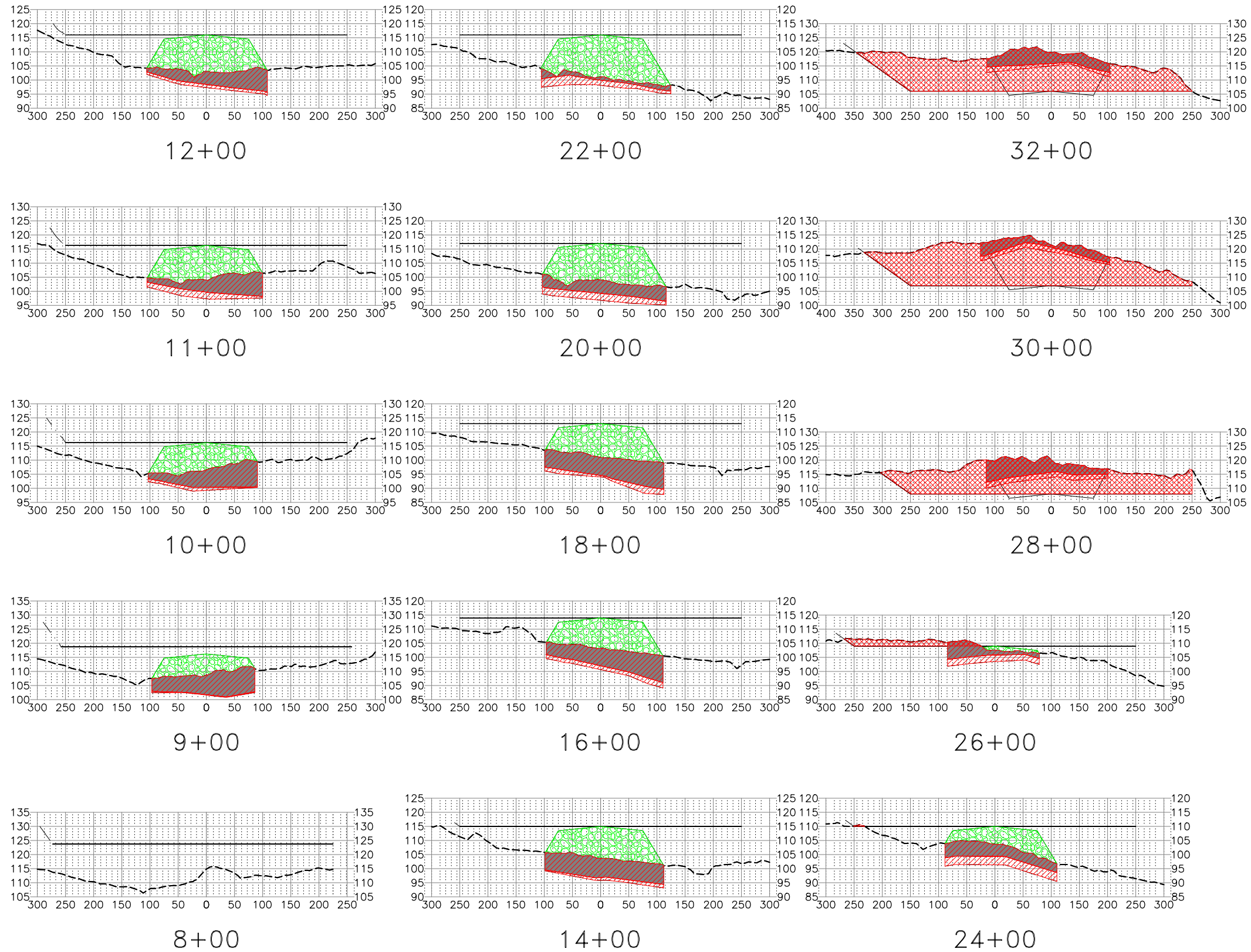

CHARLIE

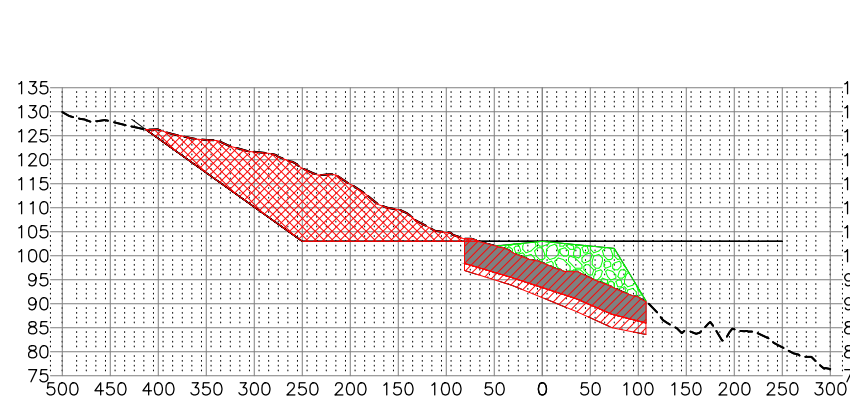

38+00

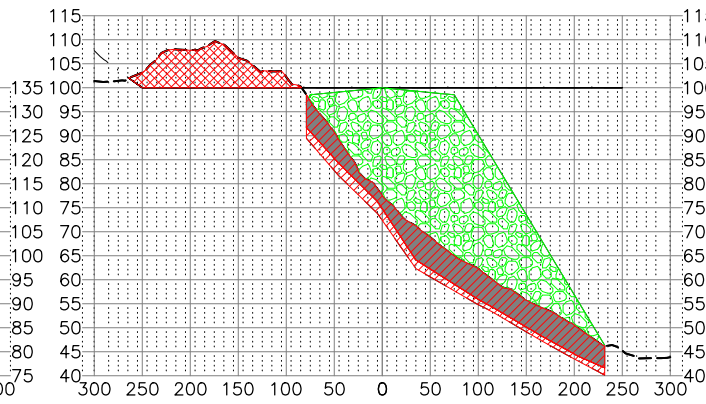

44+00

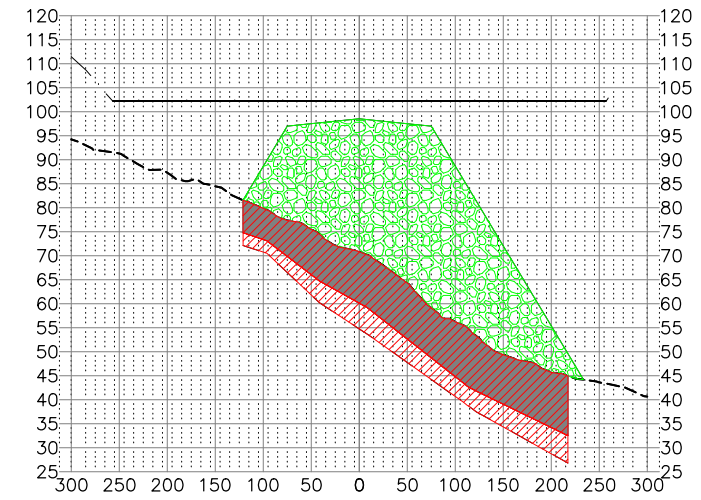

47+00

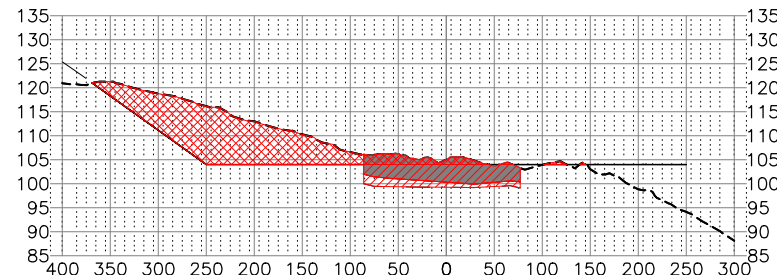

36+00

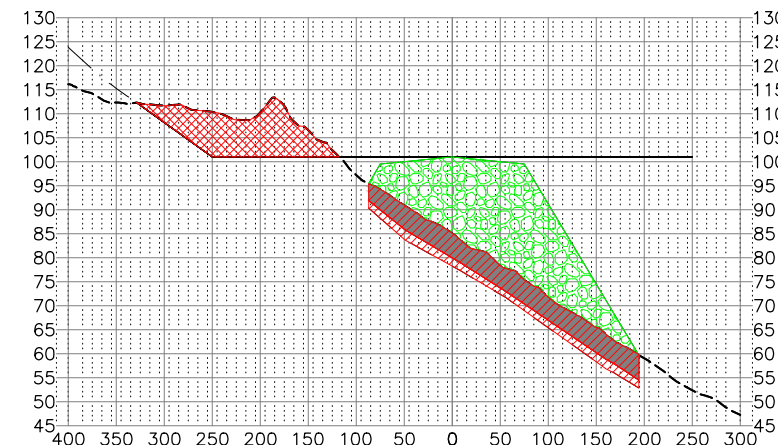

42+00

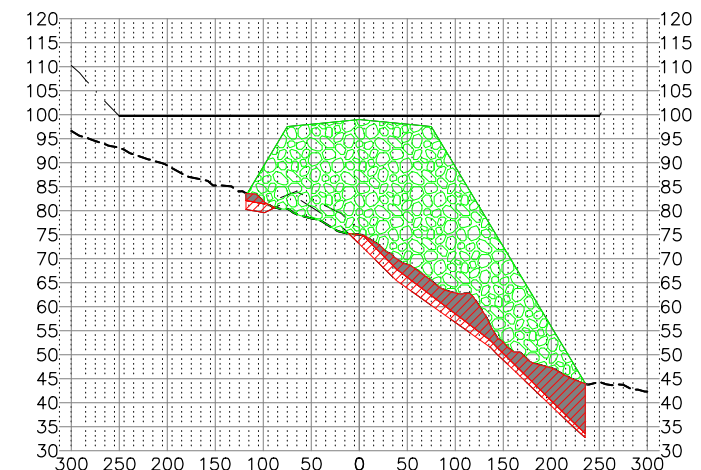

46+00

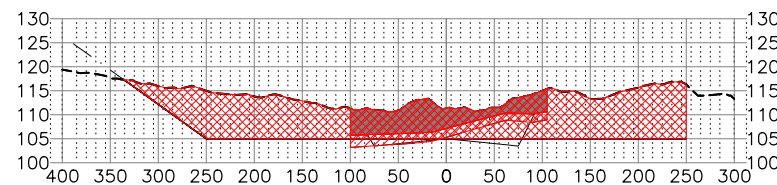

34+00

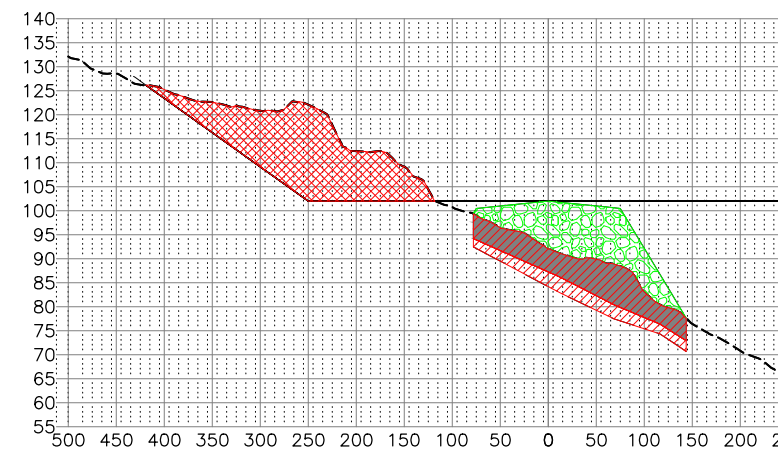

40+00

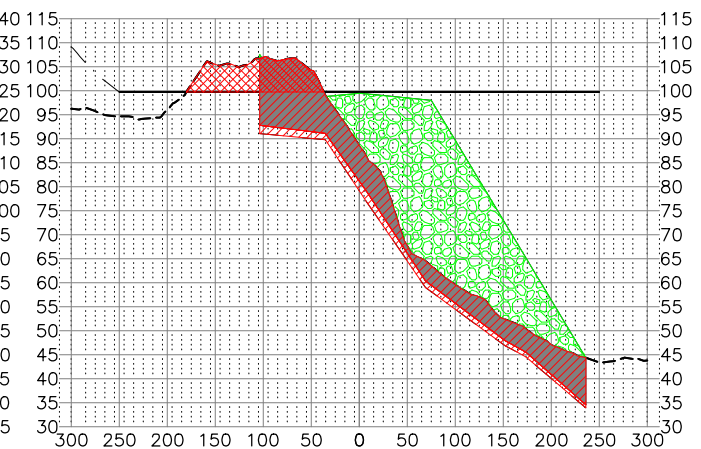

45+00

CHARLIE

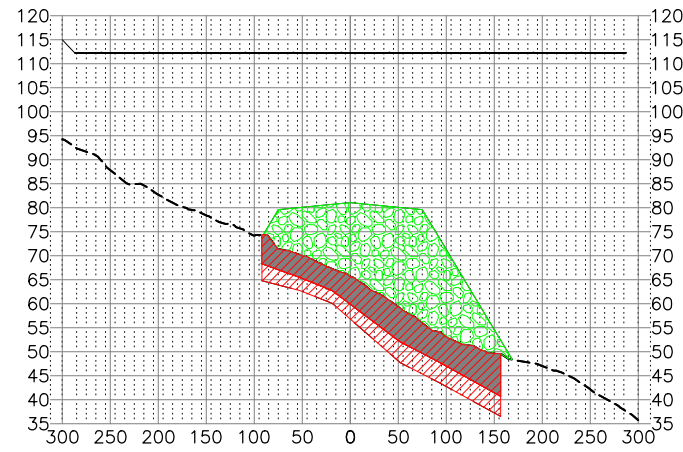

49+00

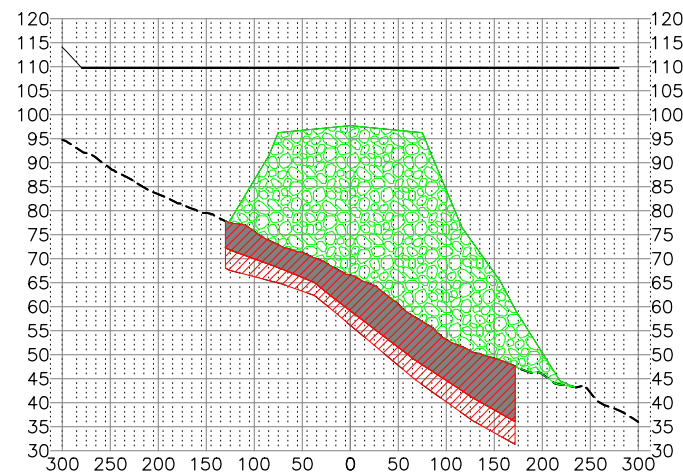

48+50

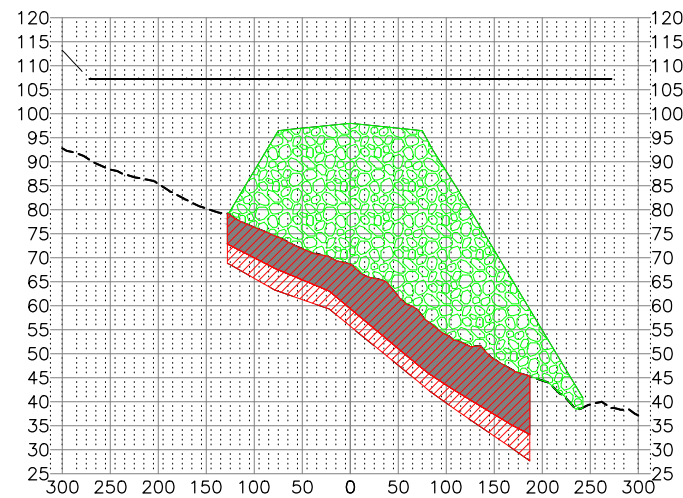

48+00

MATERIAL TABLE Peat Removal Only			
STATION	AREA	VOLUME	CUMULATIVE VOLUME
8+00.00	0.00	0.00	0.00
9+00.00	1310.94	2427.67	2427.67
10+00.00	1139.90	4538.60	6966.27
11+00.00	979.18	3924.22	10890.49
12+00.00	987.06	3641.17	14531.67
14+00.00	1441.27	8993.78	23525.45
16+00.00	1352.41	10346.94	33872.39
18+00.00	1562.72	10796.78	44669.16
20+00.00	886.16	9069.92	53739.08
22+00.00	269.28	4279.38	58018.46
24+00.00	861.75	4188.97	62207.43
26+00.00	478.88	4965.30	67172.72
28+00.00	1006.23	5500.44	72673.17
30+00.00	614.85	6004.01	78677.18
32+00.00	925.27	5704.16	84381.33
34+00.00	858.63	6607.05	90988.38
36+00.00	725.95	5868.83	96857.21
38+00.00	1001.40	6397.62	103254.83
40+00.00	1286.39	8473.30	111728.14
42+00.00	1383.32	9887.83	121615.96
44+00.00	1652.78	11244.84	132860.81
45+00.00	2413.88	7530.87	140391.68
46+00.00	966.30	6259.60	146651.28
47+00.00	3428.46	8138.45	154789.73
48+00.00	2911.83	11741.29	166531.02
48+50.00	2311.75	4836.65	171367.68
49+00.00	1500.27	3529.65	174897.33

MATERIAL TABLE Removal to Refusal			
STATION	AREA	VOLUME	CUMULATIVE VOLUME
8+00.00	0.00	0.00	0.00
9+00.00	1348.00	2496.30	2496.30
10+00.00	1310.76	4923.63	7419.93
11+00.00	1362.43	4950.36	12370.29
12+00.00	1213.77	4770.75	17141.04
14+00.00	1627.25	10522.30	27663.34
16+00.00	1661.47	12180.43	39843.77
18+00.00	1861.26	13047.12	52890.89
20+00.00	1397.73	12070.33	64961.22
22+00.00	748.58	7949.30	72910.52
24+00.00	1465.58	8200.60	81111.12
26+00.00	846.12	8561.86	89672.99
28+00.00	1406.22	8342.01	98014.99
30+00.00	934.61	8669.75	106684.74
32+00.00	1181.11	7836.01	114520.75
34+00.00	1259.69	9040.02	123560.77
36+00.00	934.25	8125.72	131686.48
38+00.00	1410.99	8686.06	140372.54
40+00.00	1868.30	12145.49	152518.03
42+00.00	1865.32	13828.22	166346.25
44+00.00	2158.99	14904.87	181251.12
45+00.00	2883.27	9337.52	190588.63
46+00.00	1432.58	7992.31	198580.94
47+00.00	4952.47	11824.17	210405.11
48+00.00	4181.17	16914.16	227319.27
48+50.00	3451.31	7067.11	234386.38
49+00.00	2407.25	5424.59	239810.98

MATERIAL TABLE P77 Excavation			
STATION	AREA	VOLUME	CUMULATIVE VOLUME
8+00.00	0.00	0.00	0.00
9+00.00	0.00	0.00	0.00
10+00.00	0.00	0.00	0.00
11+00.00	0.00	0.00	0.00
12+00.00	0.00	0.00	0.00
14+00.00	0.00	0.00	0.00
16+00.00	0.00	0.00	0.00
18+00.00	0.00	0.00	0.00
20+00.00	0.00	0.00	0.00
22+00.00	0.00	0.00	0.00
24+00.00	6.93	25.68	25.68
26+00.00	454.08	1707.45	1733.14
28+00.00	4970.99	20092.83	21825.97
30+00.00	6582.64	42791.20	64617.17
32+00.00	6124.34	47062.89	111680.06
34+00.00	4585.37	39665.61	151345.67
36+00.00	2149.08	24942.40	176288.08
38+00.00	2718.10	18026.59	194314.67
40+00.00	2839.50	20583.72	214898.39
42+00.00	1354.57	15533.61	230432.00
44+00.00	995.29	8703.19	239135.19
45+00.00	778.59	3284.95	242420.14
46+00.00	0.00	1441.82	243861.97
47+00.00	0.00	0.00	243861.97
48+00.00	0.00	0.00	243861.97
48+50.00	0.00	0.00	243861.97
49+00.00	0.00	0.00	243861.97

MATERIAL TABLE Embankment to OG			
STATION	AREA	VOLUME	CUMULATIVE VOLUME
8+00.00	0.00	0.00	0.00
9+00.00	1012.71	1875.39	1875.39
10+00.00	1460.28	4579.61	6455.00
11+00.00	1880.95	6187.45	12642.45
12+00.00	2178.44	7517.38	20159.83
14+00.00	1852.61	14929.82	35089.65
16+00.00	1785.39	13474.09	48563.74
18+00.00	1952.29	13843.26	62406.99
20+00.00	2421.18	16198.04	78605.04
22+00.00	2751.53	19158.17	97763.21
24+00.00	1096.75	14252.86	112016.07
26+00.00	116.79	4494.58	116510.65
28+00.00	0.00	432.55	116943.21
30+00.00	0.05	0.17	116943.38
32+00.00	0.11	0.58	116943.96
34+00.00	0.50	2.26	116946.22
36+00.00	0.03	1.97	116948.19
38+00.00	716.05	2652.15	119600.34
40+00.00	1701.72	8954.70	128555.04
42+00.00	3803.52	20389.77	148944.81
44+00.00	5680.75	35126.90	184071.70
45+00.00	4930.11	19649.73	203721.43
46+00.00	6753.28	21635.91	225357.34
47+00.00	7862.66	27066.56	252423.90
48+00.00	8506.16	30312.63	282736.53
48+50.00	7881.24	15173.52	297910.04
49+00.00	3532.35	10568.14	308478.18

ECHO

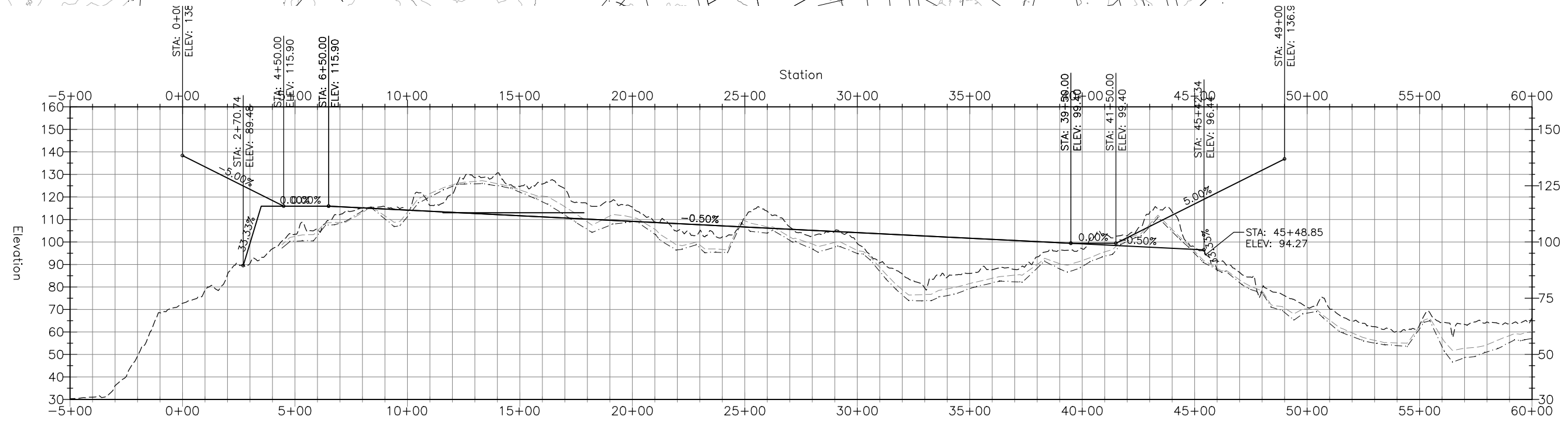
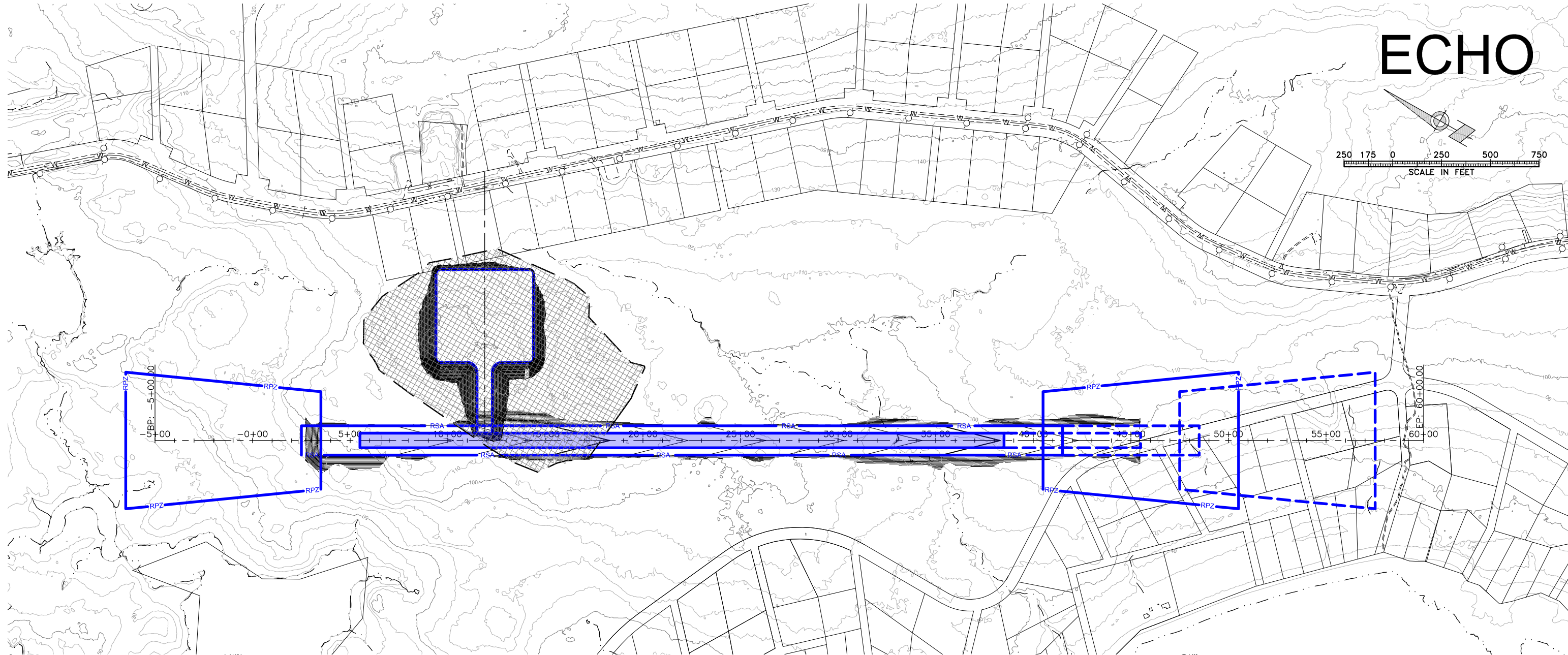
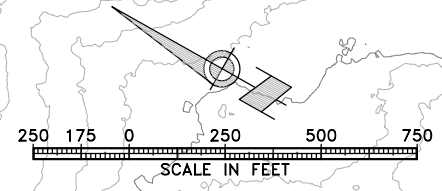

ECHO

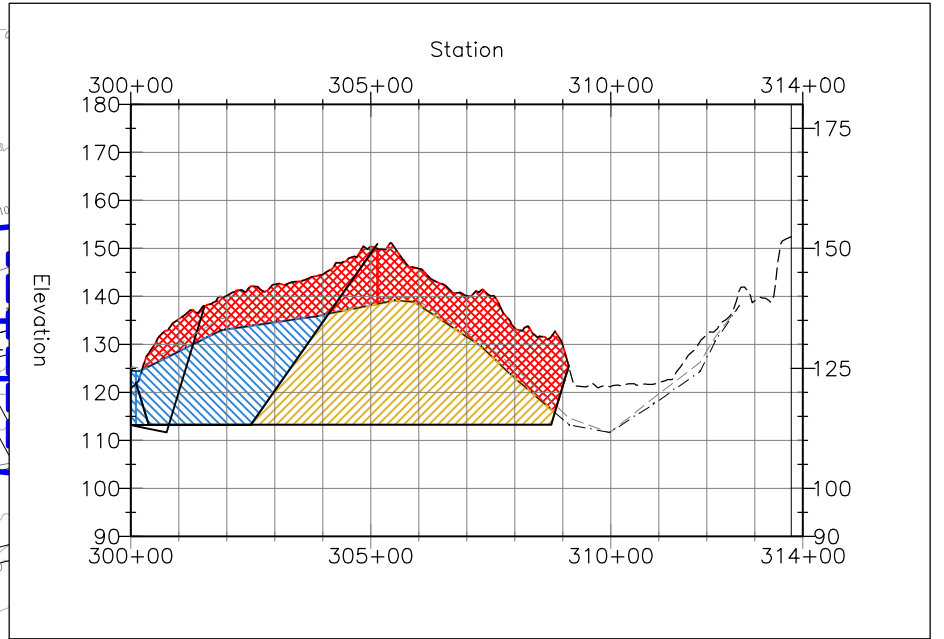
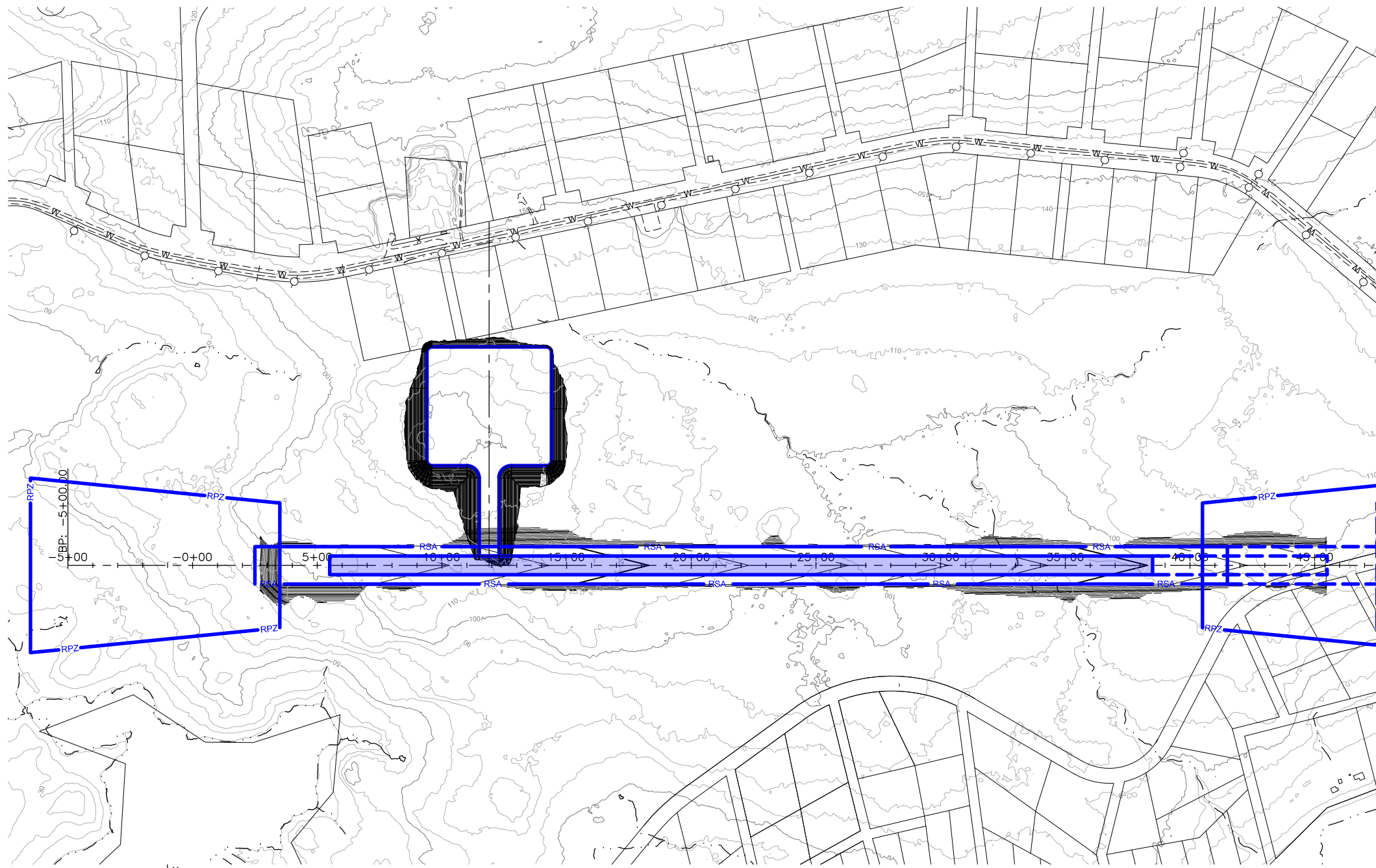
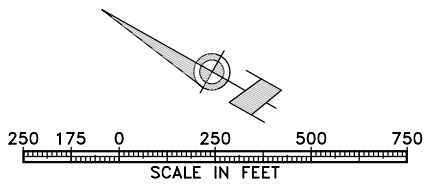

P:\2017\17171UN-Angoon_Airport\C_Model\C-MDDL-CORR-ALTS: P&P - Echo (2) Dec 11, 2017 2:03 PM

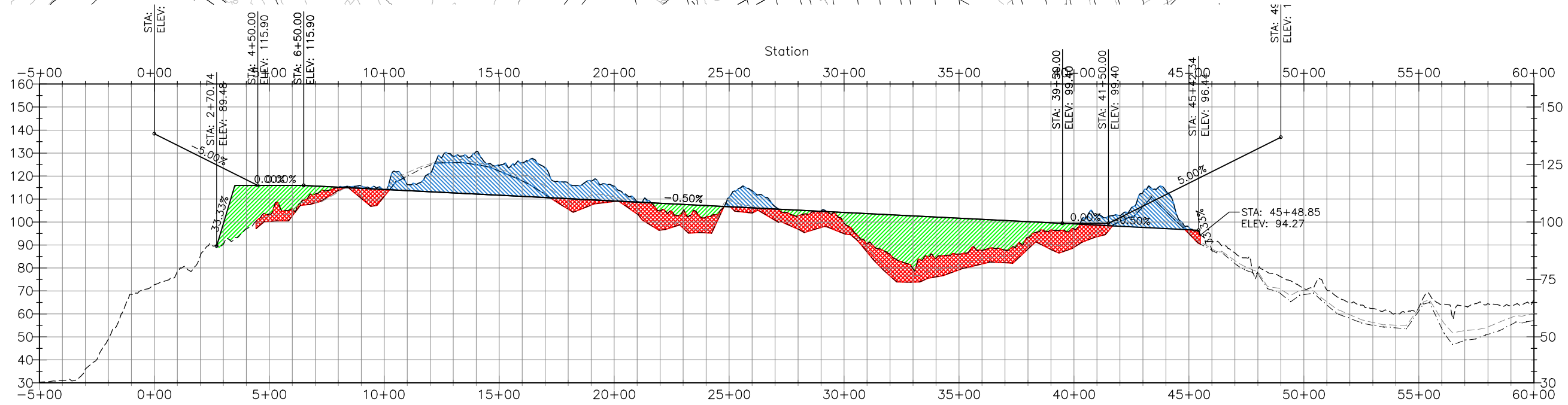

ECHO

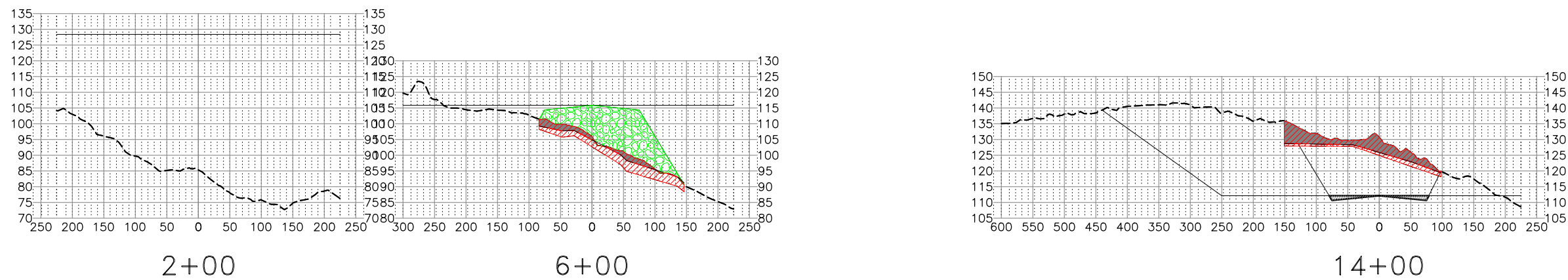
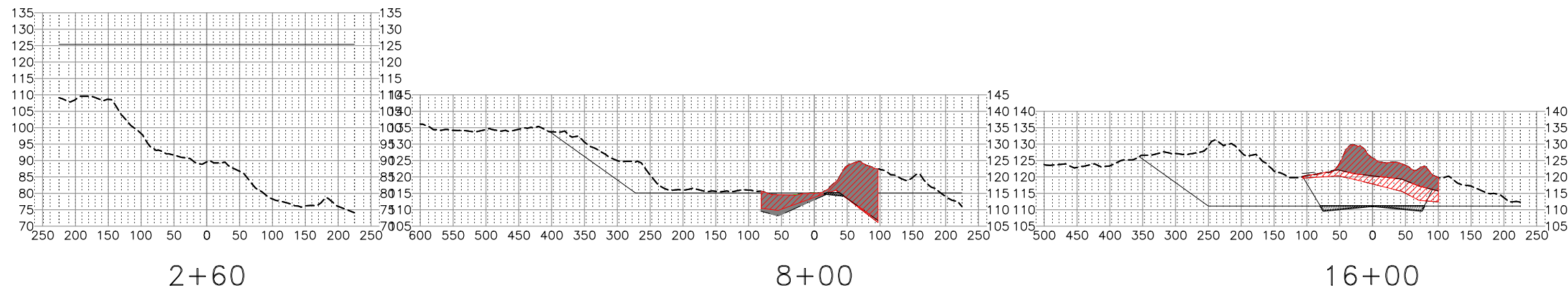
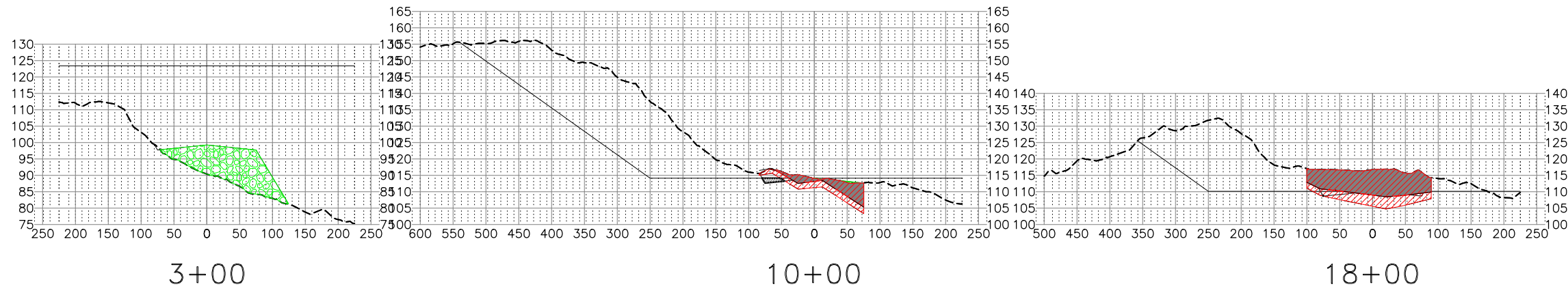
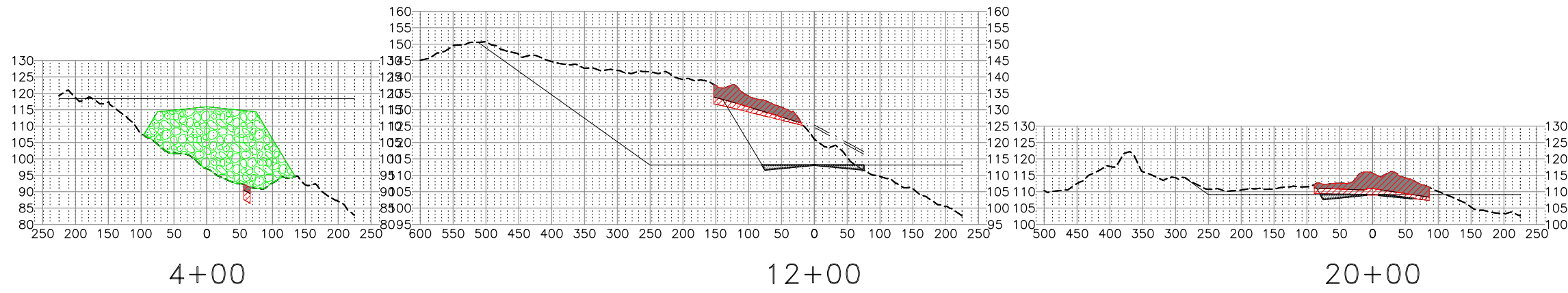

ECHO

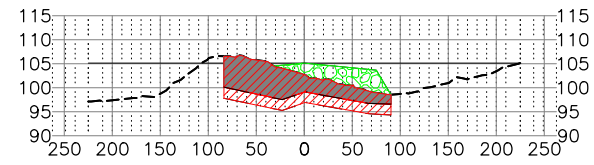

28+00

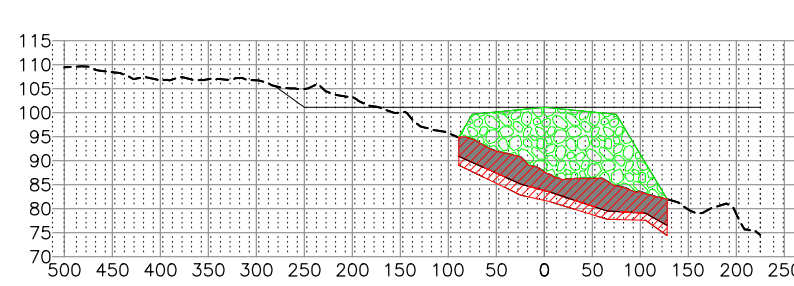

36+00

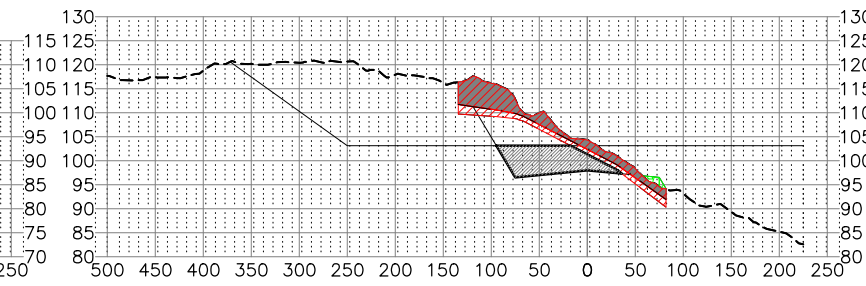

42+25

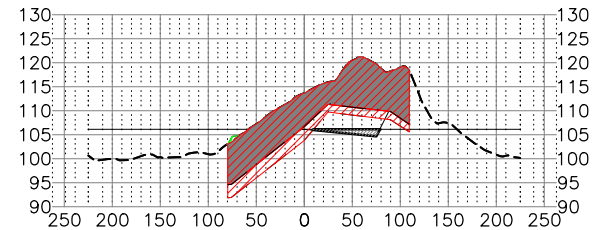

26+00

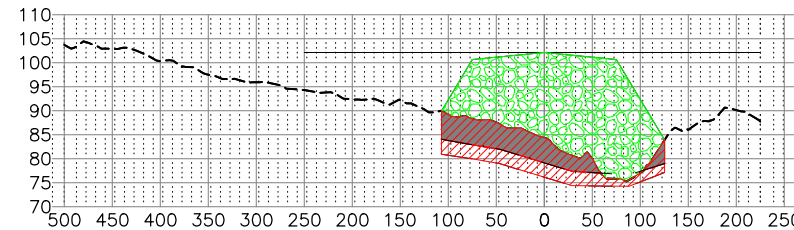

34+00

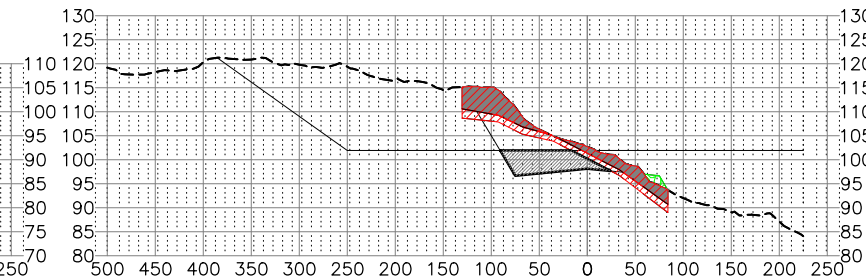

42+00

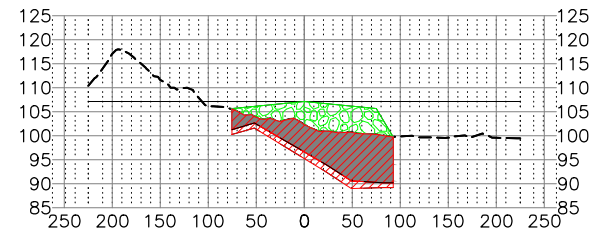

24+00

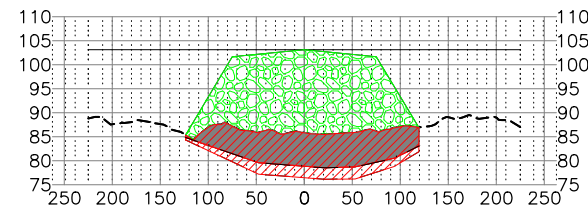

32+00

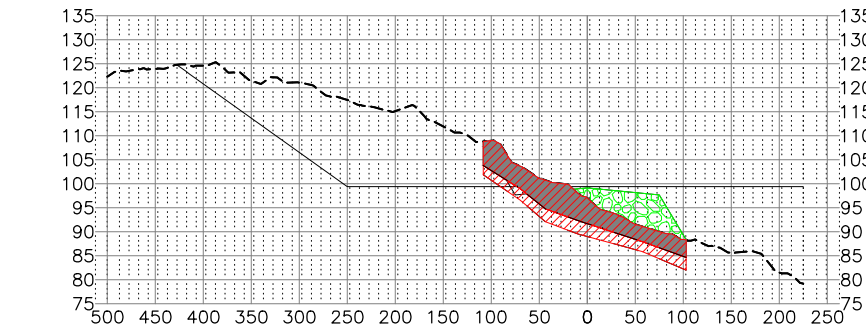

40+00

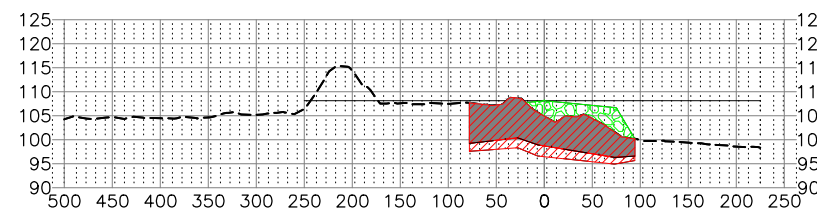

22+00

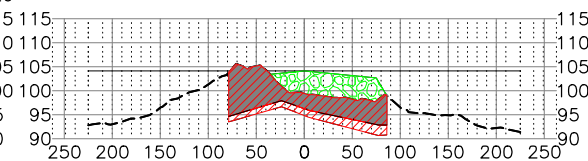

30+00

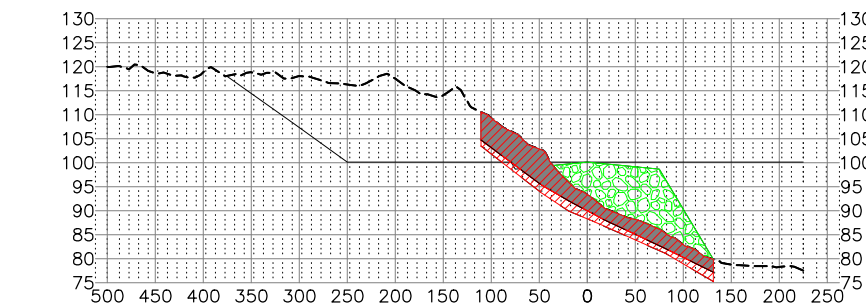

38+00

ECHO

MATERIAL TABLE Peat Removal Only			
STATION	AREA	VOLUME	CUMULATIVE VOLUME
2+00.00	0.00	0.00	0.00
2+60.00	0.00	0.00	0.00
3+00.00	0.00	0.00	0.00
4+00.00	17.25	31.94	31.94
6+00.00	246.57	977.09	1009.03
8+00.00	1181.46	5289.01	6298.04
10+00.00	329.59	5596.50	11894.54
12+00.00	441.23	2854.91	14749.45
14+00.00	742.36	4383.67	19133.12
16+00.00	842.04	5868.14	25001.25
18+00.00	1265.52	7805.76	32807.01
20+00.00	621.36	6988.42	39795.44
22+00.00	1169.95	6634.46	46429.90
24+00.00	1043.04	8196.26	54626.16
26+00.00	1553.88	9618.23	64244.39
28+00.00	791.98	8688.38	72932.77
30+00.00	864.48	6135.04	79067.81
32+00.00	1419.89	8460.60	87528.41
34+00.00	826.26	8319.07	95847.47
36+00.00	1026.25	6861.16	102708.64
38+00.00	1001.25	7509.26	110217.90
40+00.00	990.61	7377.26	117595.16
42+00.00	528.94	5627.97	123223.13
42+25.00	560.10	504.18	123727.31
43+00.00	897.28	2024.13	125751.44
44+00.00	1391.65	4238.75	129990.19
45+00.00	722.66	3915.39	133905.58
45+25.00	894.79	748.82	134654.40
45+50.00	0.00	414.25	135068.65

MATERIAL TABLE Removal to Refusal			
STATION	AREA	VOLUME	CUMULATIVE VOLUME
2+00.00	0.00	0.00	0.00
2+60.00	0.00	0.00	0.00
3+00.00	0.00	0.00	0.00
4+00.00	45.68	84.59	84.59
6+00.00	820.65	3208.63	3293.22
8+00.00	1087.93	7068.83	10362.05
10+00.00	609.83	6288.00	16650.04
12+00.00	628.19	4585.24	21235.28
14+00.00	973.42	5931.90	27167.18
16+00.00	1361.93	8649.47	35816.64
18+00.00	1798.94	11706.91	47523.55
20+00.00	881.72	9928.35	57451.91
22+00.00	1484.25	8762.85	66214.75
24+00.00	1259.17	10160.83	76375.58
26+00.00	1973.39	11972.48	88348.06
28+00.00	1182.52	11688.58	100036.63
30+00.00	1118.48	8522.22	108558.85
32+00.00	1892.90	11153.24	119712.09
34+00.00	1432.78	12317.33	132029.42
36+00.00	1440.36	10641.25	142670.67
38+00.00	1356.91	10360.23	153030.90
40+00.00	1503.38	10593.66	163624.56
42+00.00	827.11	8631.45	172256.01
42+25.00	829.76	767.07	173023.08
43+00.00	1181.81	2793.85	175816.93
44+00.00	1687.95	5314.36	181131.29
45+00.00	1010.35	4996.85	186128.14
45+25.00	1179.46	1013.80	187141.94
45+50.00	0.00	546.05	187687.99

MATERIAL TABLE Embankment to OG			
STATION	AREA	VOLUME	CUMULATIVE VOLUME
2+00.00	0.00	0.00	0.00
2+60.00	0.00	0.00	0.00
3+00.00	1495.72	1107.94	1107.94
4+00.00	3486.15	9225.69	10333.63
6+00.00	2012.51	20365.42	30699.05
8+00.00	1.35	7458.74	38157.79
10+00.00	10.01	42.05	38199.84
12+00.00	0.01	37.11	38236.94
14+00.00	0.00	0.05	38236.99
16+00.00	0.00	0.00	38236.99
18+00.00	0.00	0.00	38236.99
20+00.00	0.00	0.00	38236.99
22+00.00	341.66	1265.41	39502.39
24+00.00	668.87	3742.70	43245.09
26+00.00	6.65	2501.92	45747.01
28+00.00	345.66	1304.85	47051.86
30+00.00	501.94	3139.24	50191.11
32+00.00	3141.29	13493.42	63684.53
34+00.00	3632.33	25087.45	88771.98
36+00.00	2189.81	21563.45	110335.43
38+00.00	1270.62	12816.40	123151.84
40+00.00	537.50	6696.76	129848.60
42+00.00	31.21	2106.35	131954.95
42+25.00	26.92	26.91	131981.86
43+00.00	0.00	37.38	132019.24
44+00.00	0.00	0.00	132019.24
45+00.00	320.37	593.28	132612.52
45+25.00	495.42	377.68	132990.20
45+50.00	0.00	229.36	133219.56

MATERIAL TABLE Add'l Usable Excavation			
STATION	AREA	VOLUME	CUMULATIVE VOLUME
2+00.00	0.00	0.00	0.00
2+60.00	0.00	0.00	0.00
3+00.00	0.00	0.00	0.00
4+00.00	0.00	0.00	0.00
6+00.00	0.00	0.00	0.00
8+00.00	13.43	49.75	49.75
10+00.00	36.11	183.51	233.27
12+00.00	116.13	563.88	797.15
14+00.00	118.69	869.70	1666.85
16+00.00	118.69	879.17	2546.02
18+00.00	0.00	439.58	2985.60
20+00.00	61.86	229.12	3214.73
22+00.00	0.00	229.12	3443.85
24+00.00	0.00	0.00	3443.85
26+00.00	58.21	215.59	3659.44
28+00.00	0.00	215.59	3875.03
30+00.00	0.00	0.00	3875.03
32+00.00	0.00	0.00	3875.03
34+00.00	0.00	0.00	3875.03
36+00.00	0.00	0.00	3875.03
38+00.00	0.00	0.00	3875.03
40+00.00	0.00	0.00	3875.03
42+00.00	388.91	1440.42	5315.45
42+25.00	554.62	436.82	5752.27
43+00.00	1323.95	2609.12	8361.40
44+00.00	1101.77	4492.08	12853.48
45+00.00	98.11	2222.01	15075.49
45+25.00	52.37	69.67	15145.15
45+50.00	0.00	24.25	15169.40

P:\2017\17171UN-Angoon_Airport\C_Model\C-MDDL-CORR-ALTS: XSEC-echo (3) Dec 11, 2017 1:07 PM

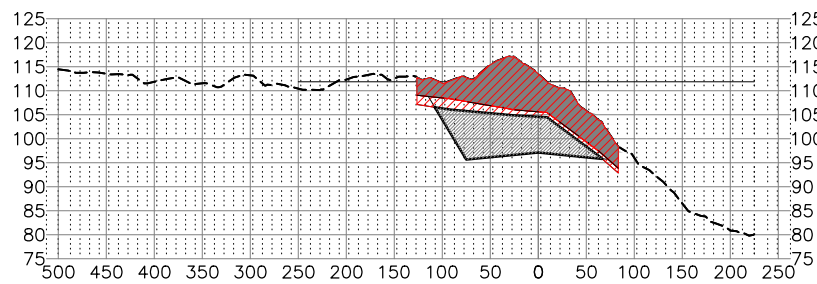

44+00

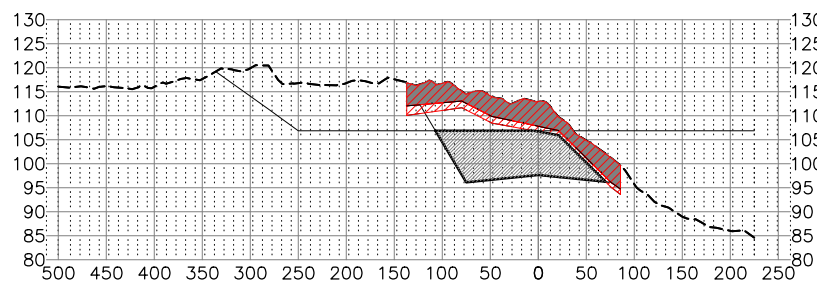

43+00

ECHO P77 Excavation

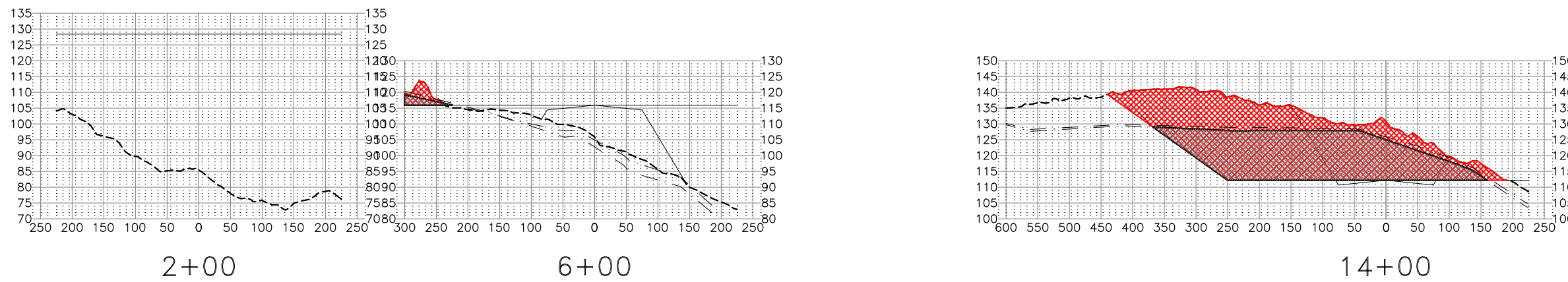
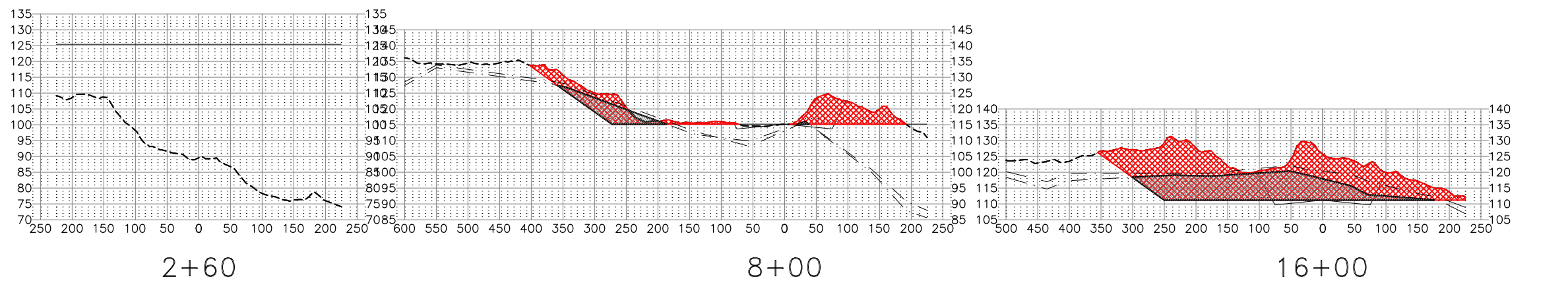
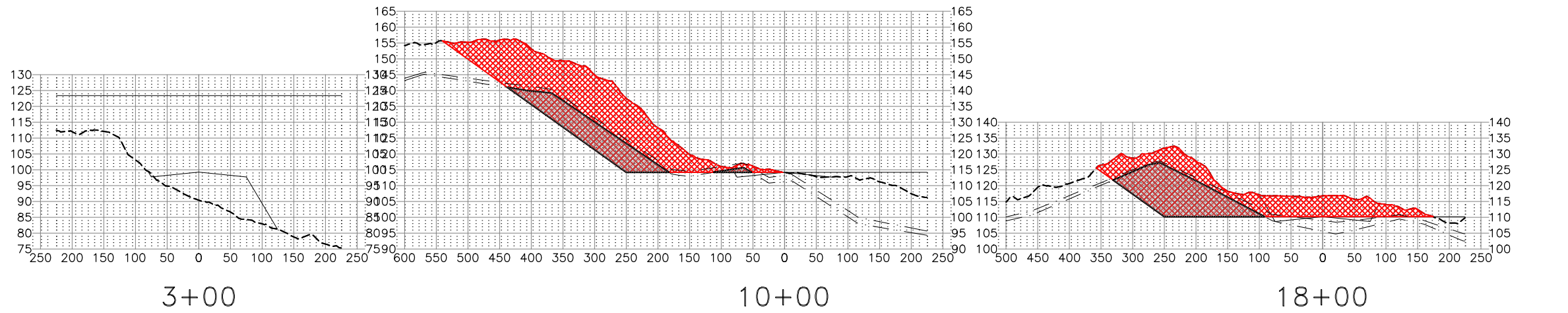
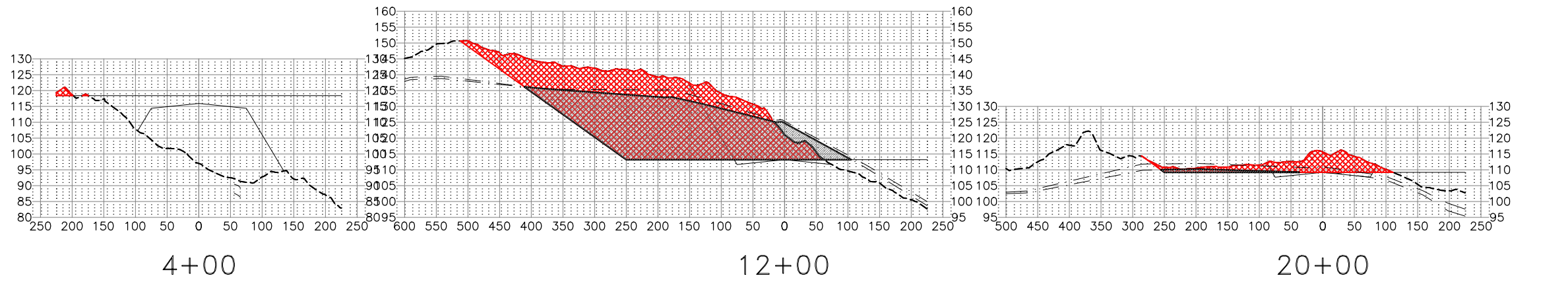

ECHO P77 Excavation

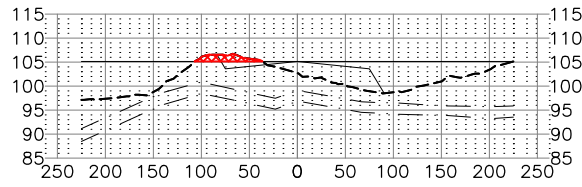

28+00

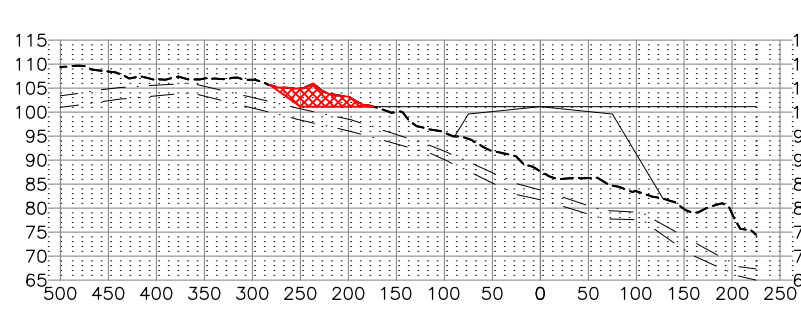

36+00

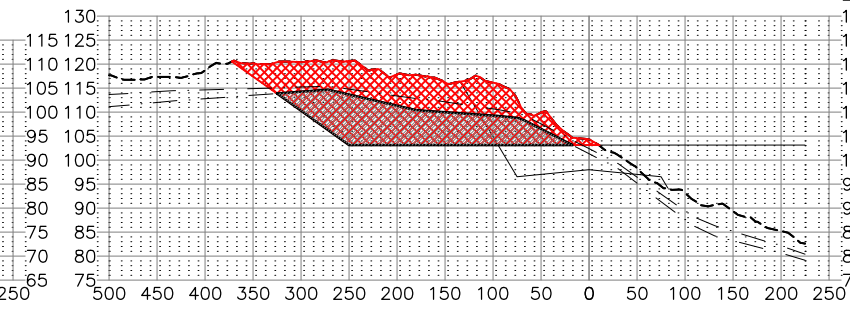

42+25

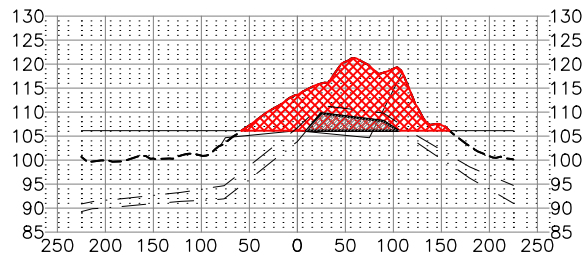

26+00

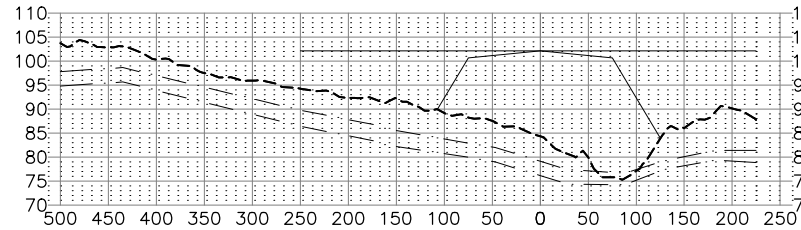

34+00

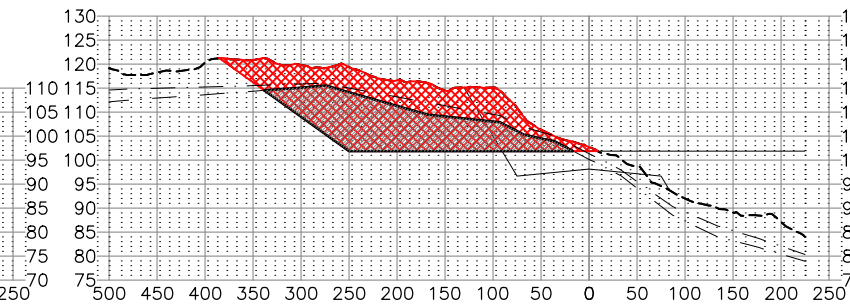

42+00

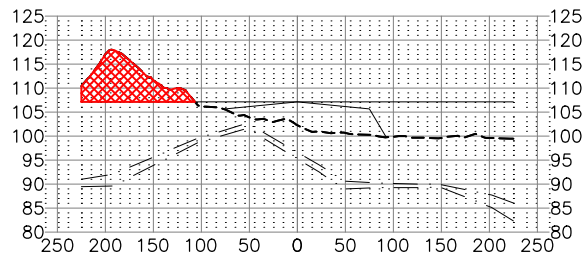

24+00

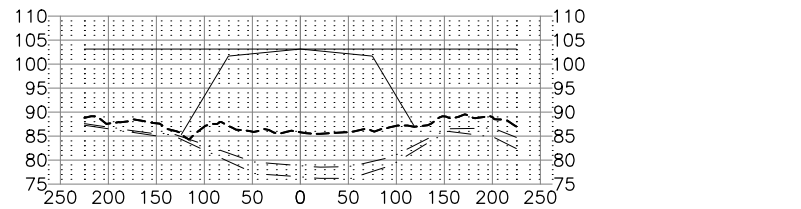

32+00

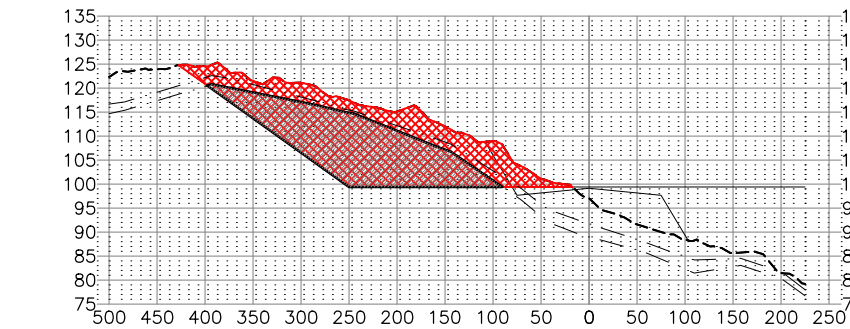

40+00

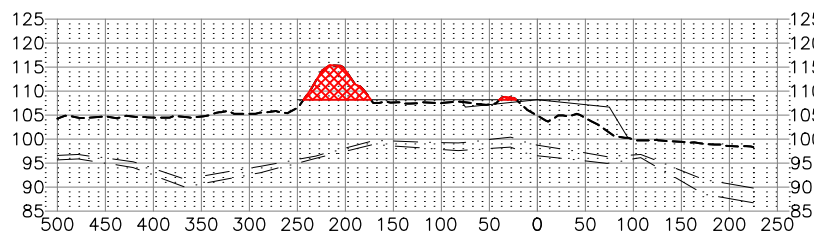

22+00

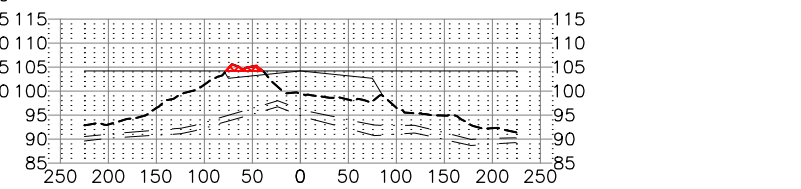

30+00

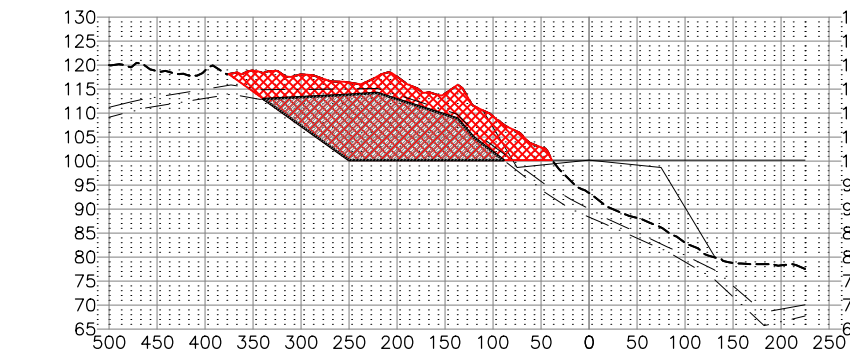

38+00

ECHO P77 Excavation

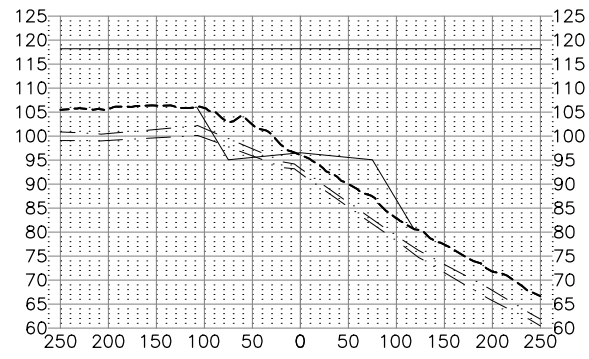

45+25

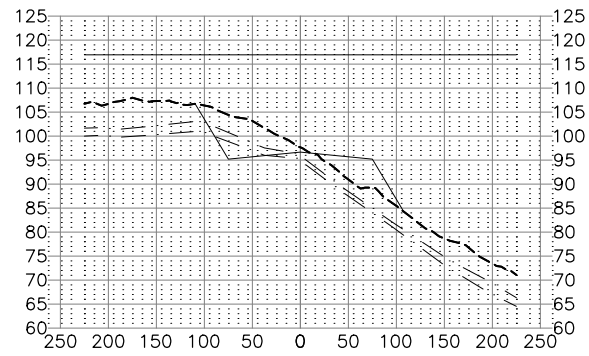

45+00

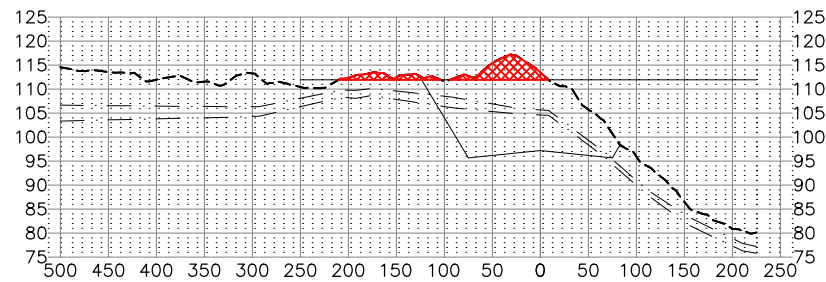

44+00

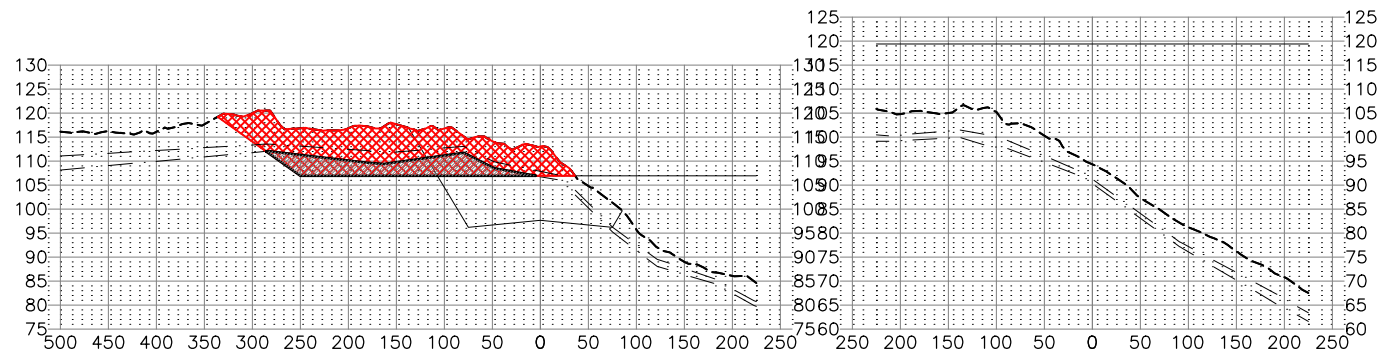

43+00

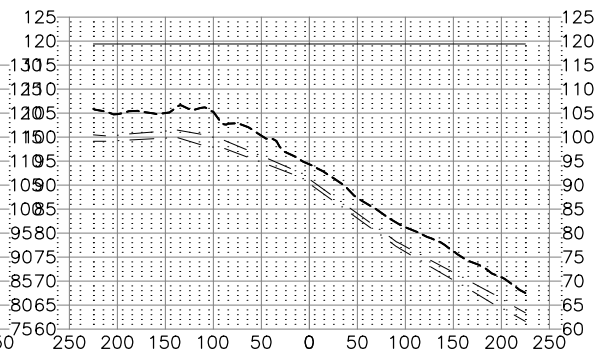

45+50

MATERIAL TABLE P77 Total Excavation				MATERIAL TABLE P77 Usable Excavation			
STATION	AREA	VOLUME	CUMULATIVE VOLUME	STATION	AREA	VOLUME	CUMULATIVE VOLUME
2+00.00	0.00	0.00	0.00	2+00.00	0.00	0.00	0.00
2+60.00	0.00	0.00	0.00	2+60.00	0.00	0.00	0.00
3+00.00	0.00	0.00	0.00	3+00.00	0.00	0.00	0.00
4+00.00	43.52	80.60	80.60	4+00.00	0.00	0.00	0.00
6+00.00	263.32	1136.47	1217.07	6+00.00	123.81	458.56	458.56
8+00.00	1918.08	8079.25	9296.32	8+00.00	558.64	2527.60	2986.16
10+00.00	6485.52	31124.43	40420.75	10+00.00	1643.77	8157.09	11143.25
12+00.00	9144.85	57890.24	98310.99	12+00.00	6449.93	29976.67	41119.92
14+00.00	9885.70	70483.51	168794.49	14+00.00	5924.22	45830.19	86950.12
16+00.00	6204.10	59591.86	228386.35	16+00.00	2638.60	31714.18	118664.30
18+00.00	4642.65	40173.14	268559.49	18+00.00	2038.34	17322.00	135986.30
20+00.00	1154.75	21471.83	290031.32	20+00.00	130.13	8031.34	144017.64
22+00.00	313.55	5438.12	295469.44	22+00.00	0.00	481.95	144499.58
24+00.00	687.75	3708.50	299177.94	24+00.00	0.00	0.00	144499.58
26+00.00	1727.47	8945.25	308123.20	26+00.00	223.41	827.45	145327.03
28+00.00	69.86	6656.79	314779.99	28+00.00	0.00	827.45	146154.48
30+00.00	31.60	375.80	315155.79	30+00.00	0.00	0.00	146154.48
32+00.00	0.00	117.04	315272.83	32+00.00	0.00	0.00	146154.48
34+00.00	0.00	0.00	315272.83	34+00.00	0.00	0.00	146154.48
36+00.00	238.52	883.40	316156.23	36+00.00	0.00	0.00	146154.48
38+00.00	3625.19	14310.02	330466.25	38+00.00	2149.77	7962.13	154116.61
40+00.00	4162.90	28844.76	359311.01	40+00.00	2591.53	17560.39	171677.00
42+00.00	3889.34	29823.08	389134.09	42+00.00	2140.85	17527.35	189204.36
42+25.00	3867.32	3591.05	392725.14	42+25.00	1904.65	1872.92	191077.27
43+00.00	2883.15	9375.65	402100.79	43+00.00	808.81	3768.70	194845.97
44+00.00	351.52	5990.13	408090.92	44+00.00	0.00	1497.80	196343.77
45+00.00	0.00	650.97	408741.89	45+00.00	0.00	0.00	196343.77
45+25.00	0.00	0.00	408741.89	45+25.00	0.00	0.00	196343.77
45+50.00	0.00	0.00	408741.89	45+50.00	0.00	0.00	196343.77

ECHO Knob Excavation

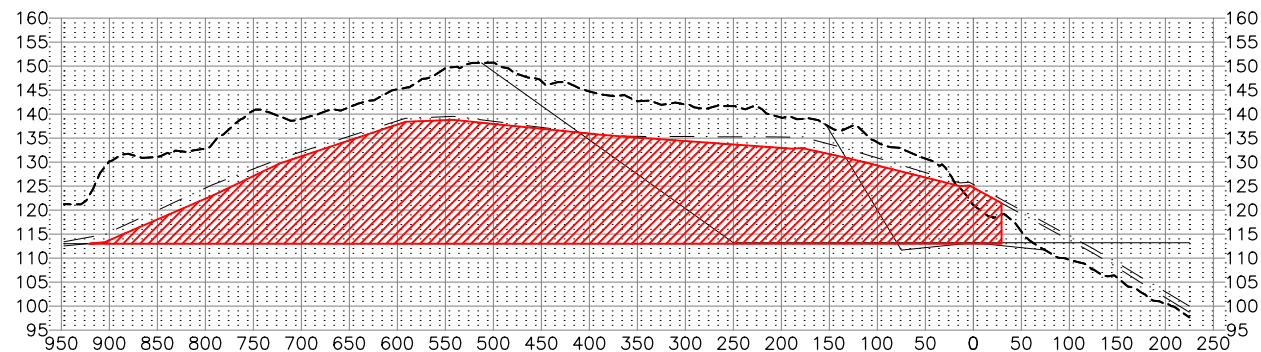

12+00

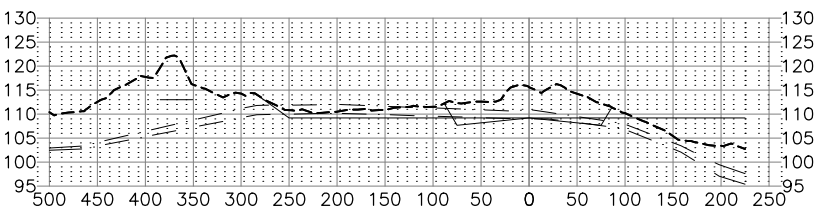

20+00

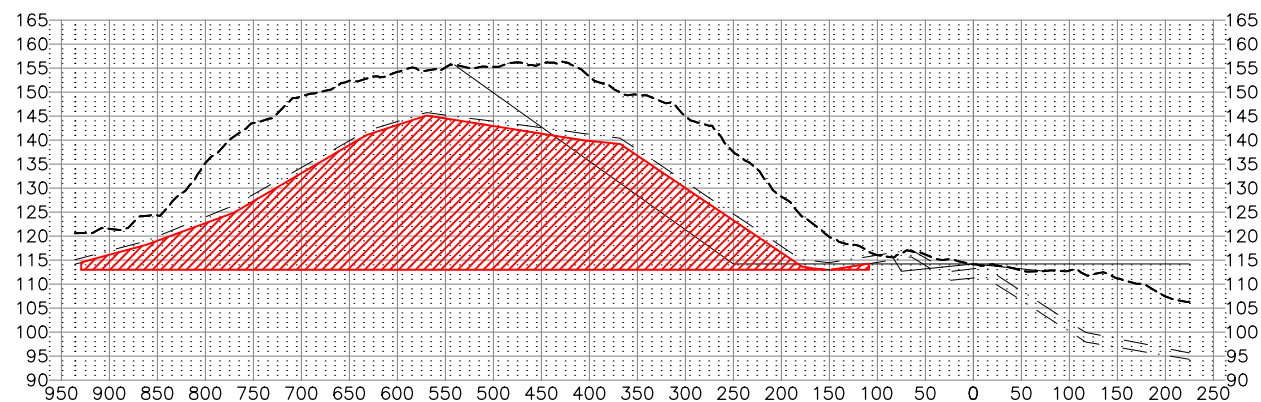

10+00

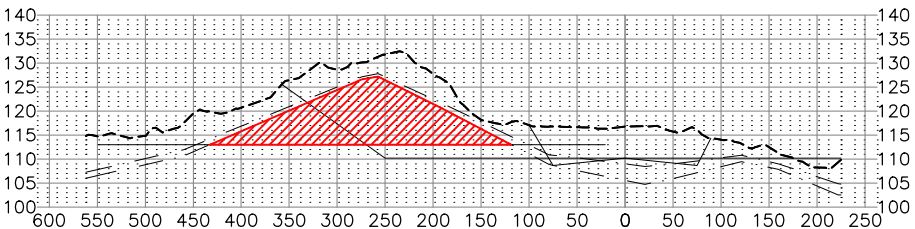

18+00

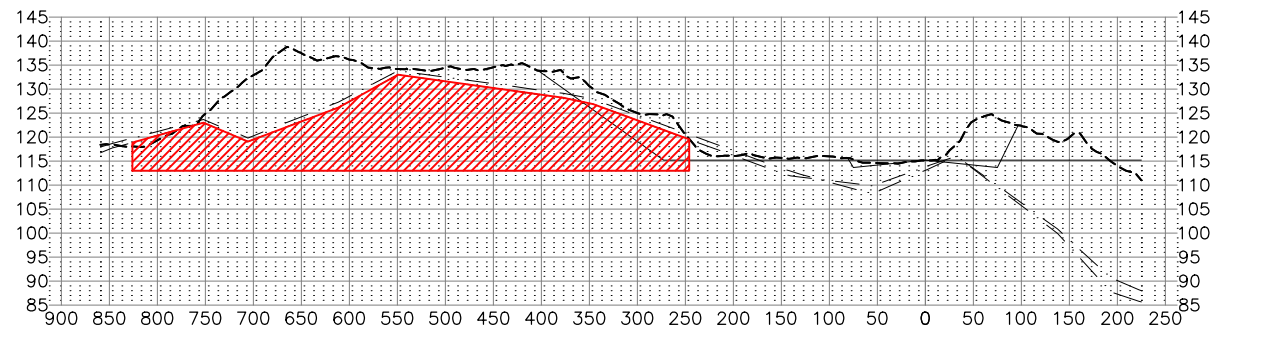

8+00

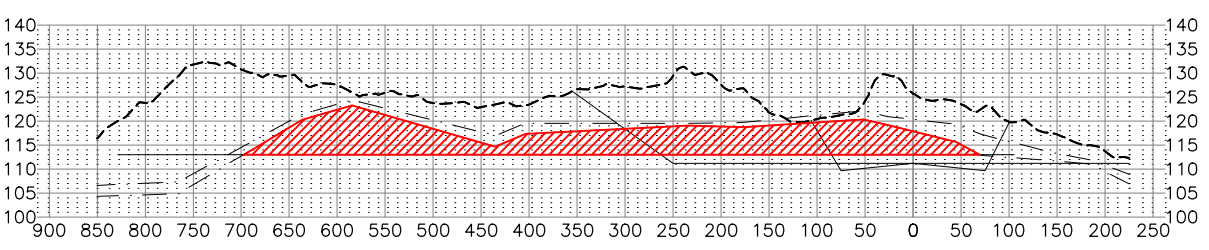

16+00

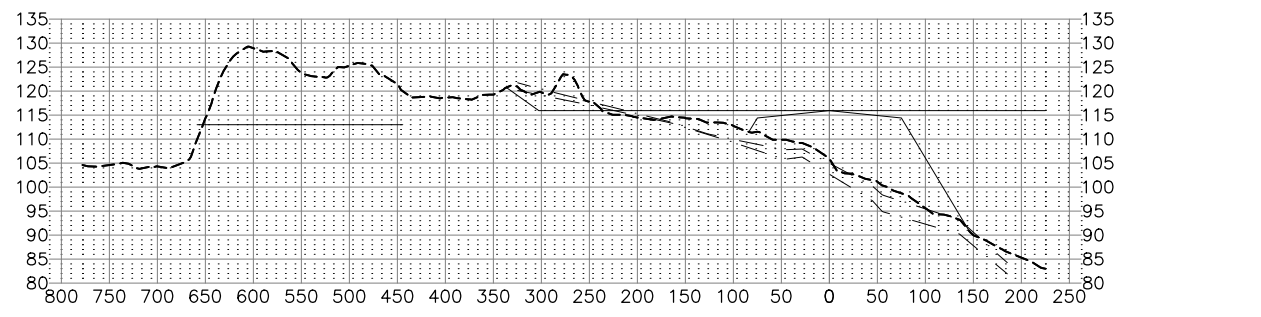

6+00

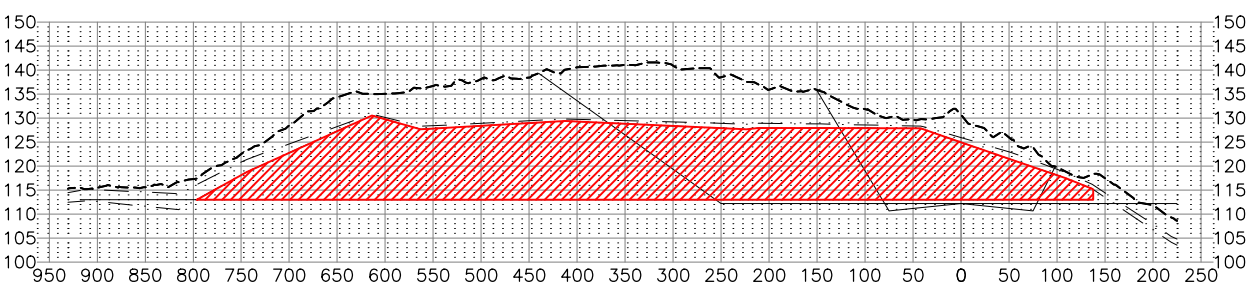

14+00

MATERIAL TABLE Ground Removed			
STATION	AREA	VOLUME	CUMULATIVE VOLUME
2+00.00	0.00	0.00	0.00
2+60.00	0.00	0.00	0.00
3+00.00	0.00	0.00	0.00
4+00.00	0.00	0.00	0.00
6+00.00	0.00	0.00	0.00
8+00.00	7381.24	27337.94	27337.94
10+00.00	14035.73	79322.13	106660.07
12+00.00	16789.67	114168.14	220828.21
14+00.00	11994.08	106606.46	327434.66
16+00.00	4196.16	59963.83	387398.49
18+00.00	2305.54	24080.36	411478.85
20+00.00	0.00	8539.03	420017.88
22+00.00	0.00	0.00	420017.88
24+00.00	0.00	0.00	420017.88
26+00.00	0.00	0.00	420017.88
28+00.00	0.00	0.00	420017.88
30+00.00	0.00	0.00	420017.88
32+00.00	0.00	0.00	420017.88
34+00.00	0.00	0.00	420017.88
36+00.00	0.00	0.00	420017.88
38+00.00	0.00	0.00	420017.88
40+00.00	0.00	0.00	420017.88
42+00.00	0.00	0.00	420017.88
42+25.00	0.00	0.00	420017.88
43+00.00	0.00	0.00	420017.88
44+00.00	0.00	0.00	420017.88
45+00.00	0.00	0.00	420017.88
45+25.00	0.00	0.00	420017.88
45+50.00	0.00	0.00	420017.88

Angoon Alternative Analysis of South Approaches 12/8/2017

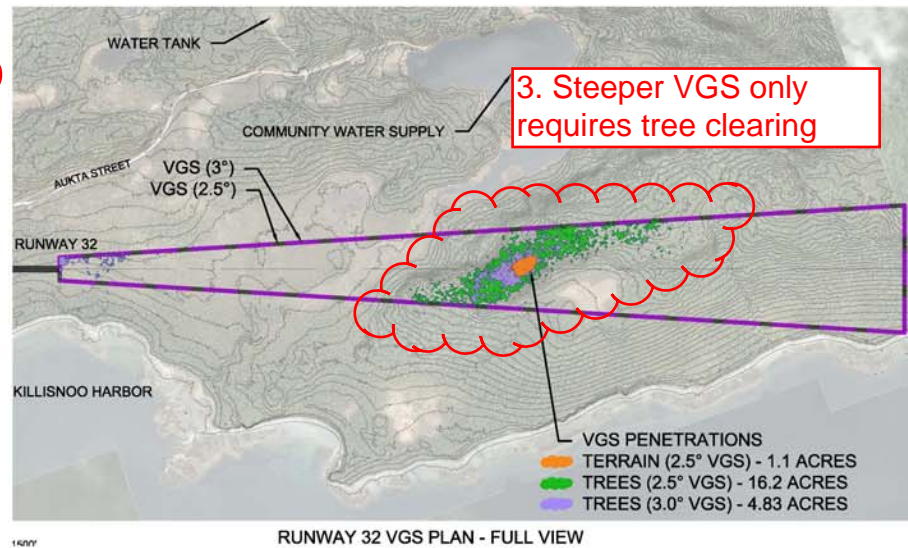
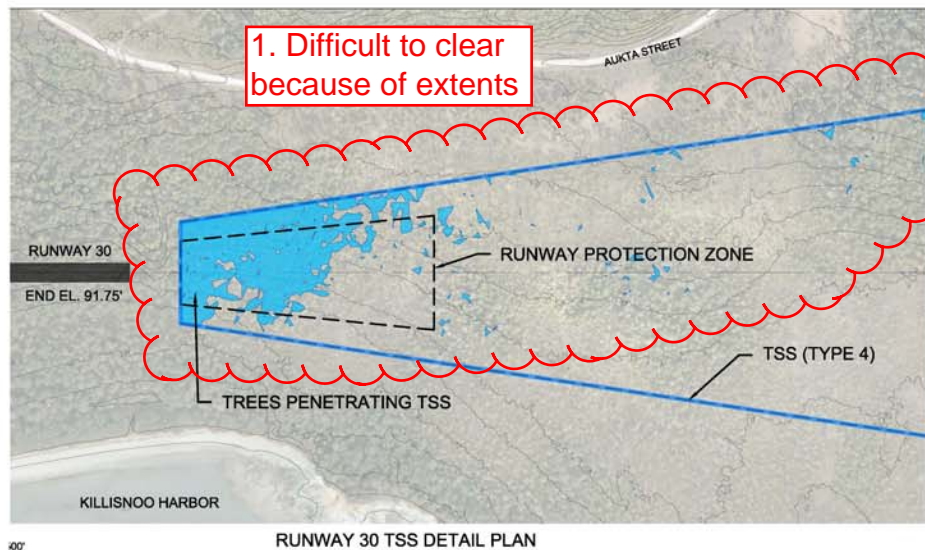
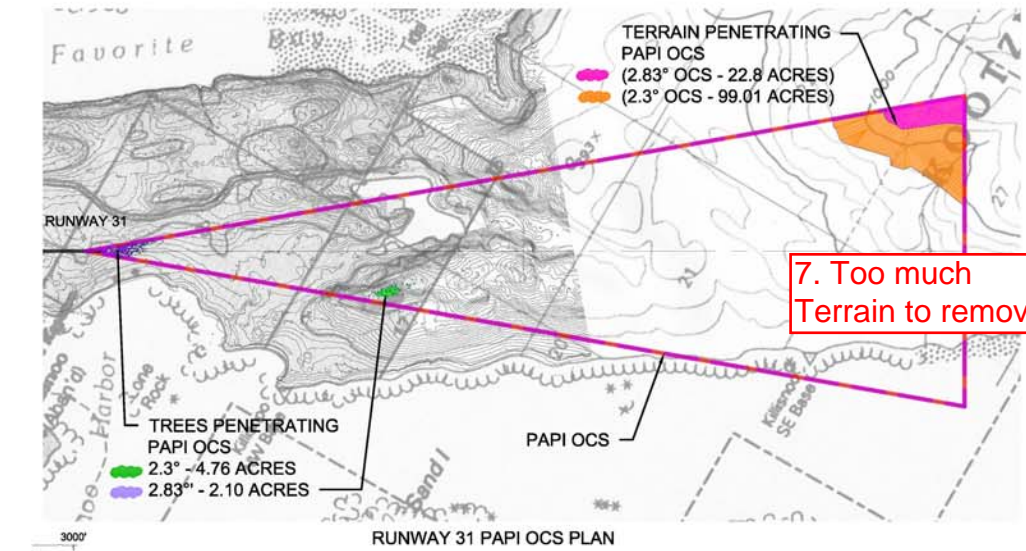
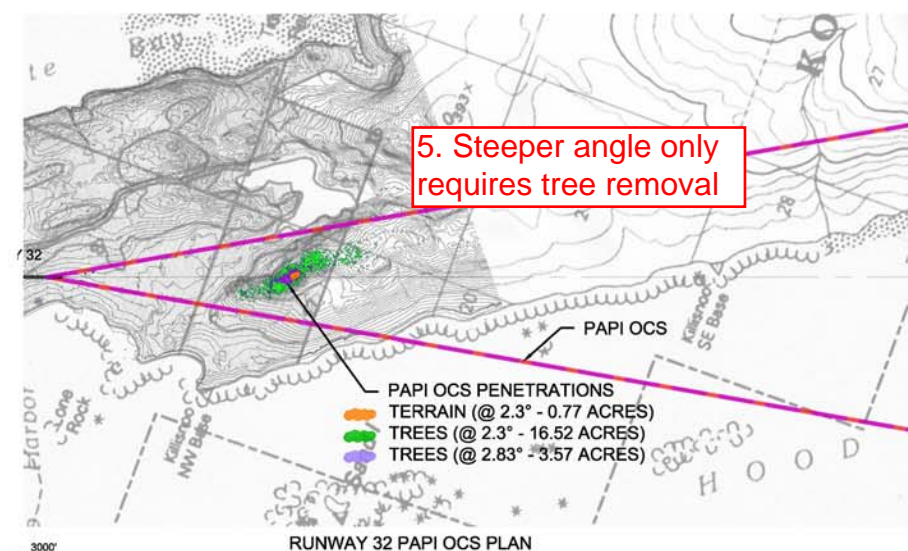
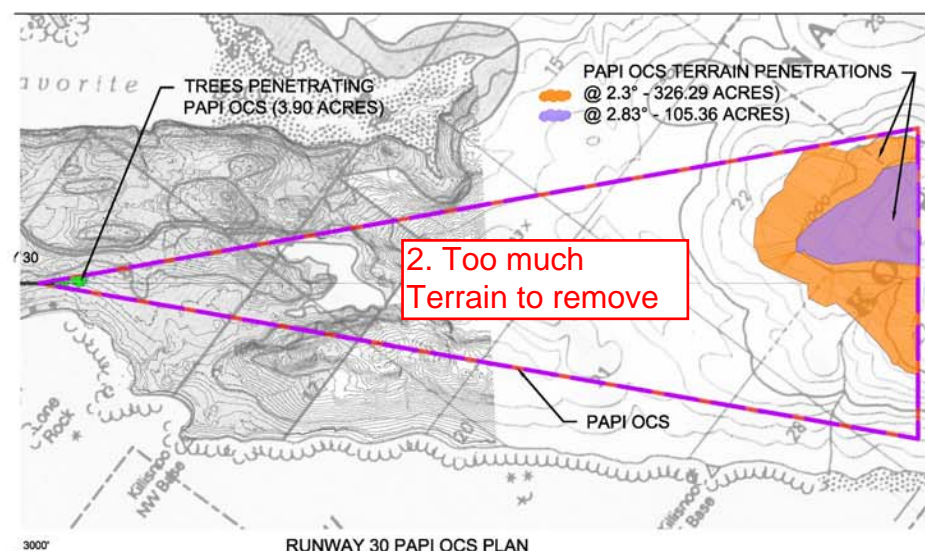
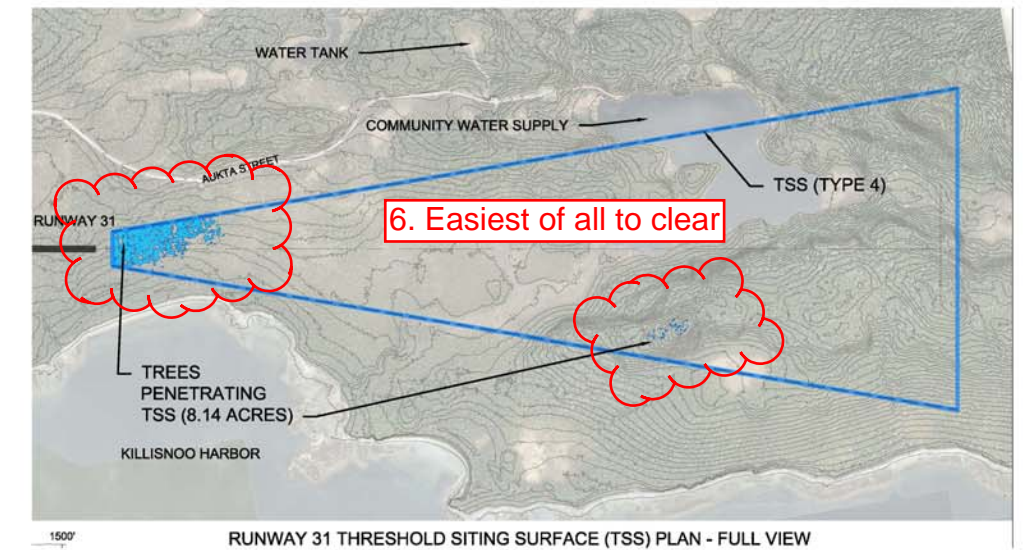
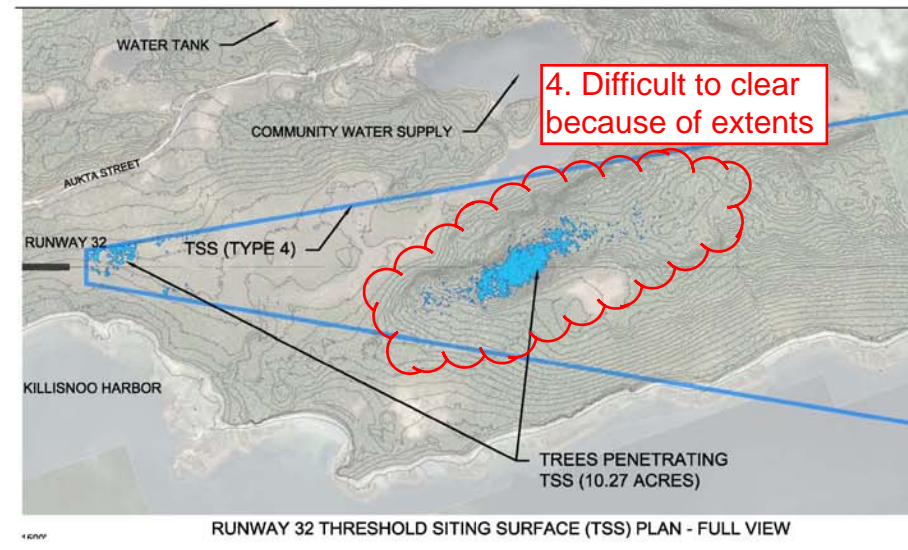
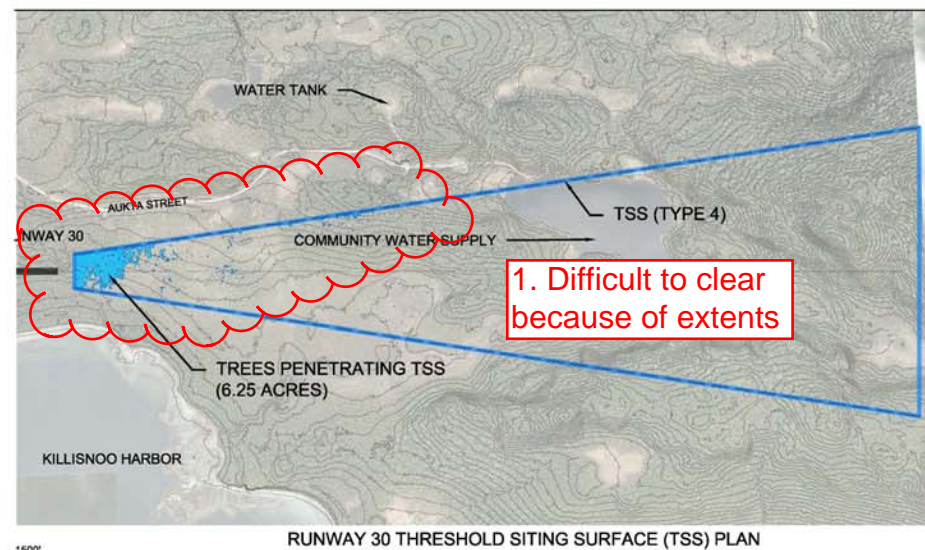

Table 4 RUNWAY ALIGNMENT OBSTRUCTION EVALUATION SUMMARY

Runway Alignment	Potential Vertically-Guided Instrument Approach Procedure	Potential Instrument Night Operations	Potential PAPI Installation
Alpha Runway Alternative			
Runway 12/30			
Runway 12	Yes	1. Yes	Yes
Runway 30	Yes ¹	Yes ¹	No 2.
Charlie Runway Alternative			
Runway 14/32			
Runway 14	Yes	Yes	Yes
Runway 32	Yes ¹ 3.	Yes ¹ 4.	Yes ¹ 5.
Echo Runway Alternative			
Runway 13/31			
Runway 13	Yes	Yes	Yes
Runway 31	Yes	Yes ¹ 6.	No 7.

Source: Preliminary criteria assessment provided by Mead & Hunt Inc.
¹ Existing tree obstruction removal would be required pending feasibility determination.









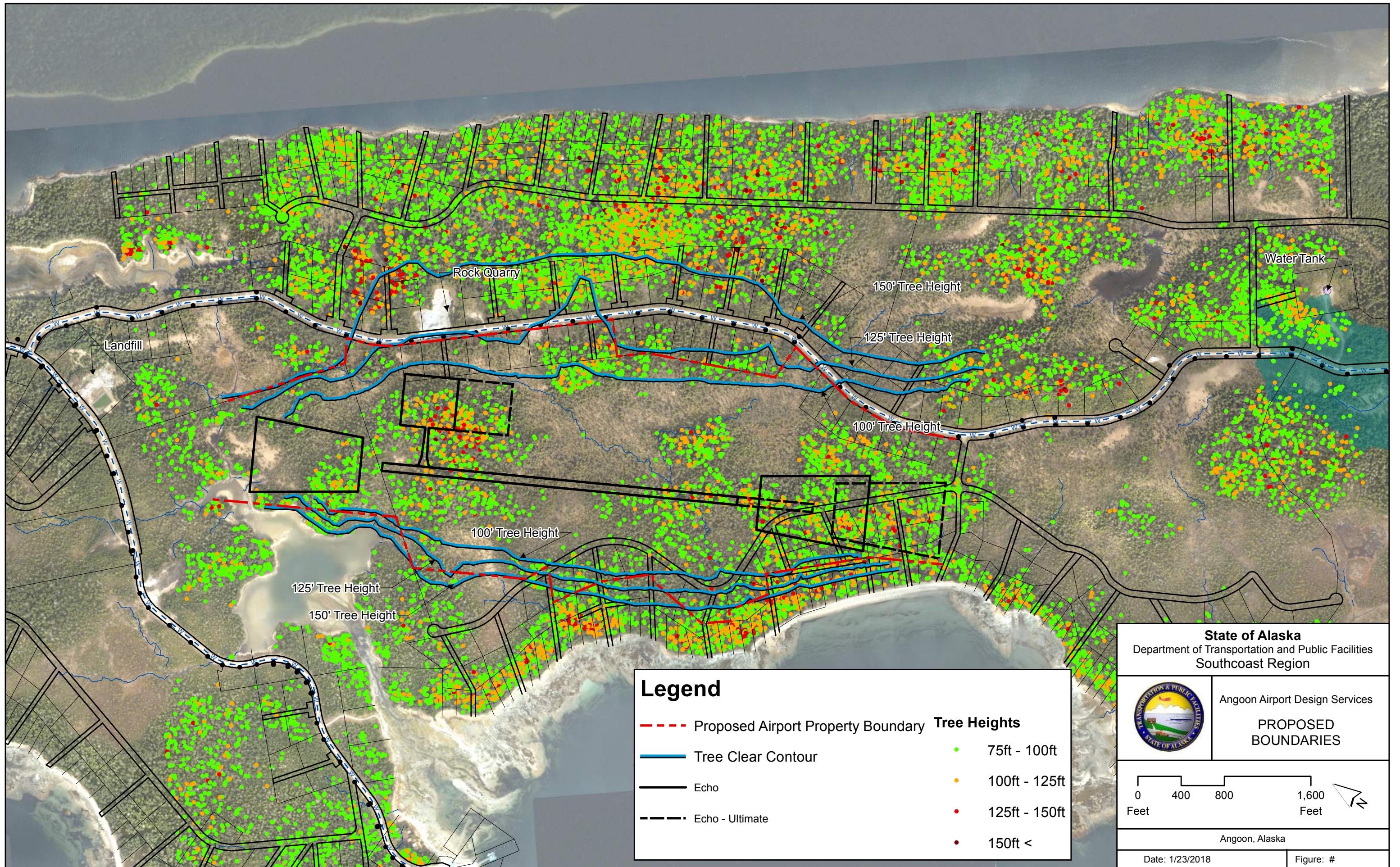

Alternative A

Alternative C

Alternative E



Legend

	Proposed Airport Property Boundary	Tree Heights
	Tree Clear Contour	 75ft - 100ft
	Echo	 100ft - 125ft
	Echo - Ultimate	 125ft - 150ft
		 150ft <

State of Alaska
Department of Transportation and Public Facilities
Southcoast Region

 Angoon Airport Design Services

PROPOSED BOUNDARIES

0 400 800 1,600
Feet Feet

Angoon, Alaska

Date: 1/23/2018 Figure: #



APPENDIX F

GEOTECHNICAL CONSIDERATIONS

TECHNICAL MEMORANDUM

Client #	IRIS # SFAPT00086	Date	12/12/2017
PDC #	17171JN	Prepared by	Cody Kreitel, PE
Project Name	Angoon Airport	Reviewed by	Mark Pusich, PE Brian Hanson, PE Royce Conlon, PE
Subject	<i>Geotechnical Considerations Memorandum</i>		

Topic	Discussion
--------------	-------------------

Introduction

The information presented in this memorandum is based on two site visits conducted by PDC engineering staff and a review of the subsurface data collected by the Alaska Department of Transportation & Public Facilities Southcoast Region (DOT). From a geotechnical perspective, the first site visit consisted of an overview of the project site and four concept alignments (Alpha, Bravo, Charlie, and Delta), familiarization with the materials encountered during recent subsurface exploration activities conducted by DOT, and identification of potential material sources. As a result of the first site visit, a fifth concept alignment (Echo) was developed. Before the second site visit, the five concept alignments have been narrowed to three alignment alternatives: Alpha, Charlie, and Echo. During the second site visit, Cody Kreitel (PDC) assisted the DOT geologist with collecting hand probe data in an effort to provide additional data for the three runway alignment alternatives.

During the subsurface explorations/data collection performed to date, four general geologic materials have been identified: surficial organics, glacial outwash (which consisted of varying amounts of silts, sands, and gravels) glacial till (generally fine grained and overconsolidated), and bedrock. The glacial outwash and glacial till materials are discontinuous across the site. Along the three alignments being considered, surficial organics range in depth from very thin (6 inches or less) to over 10 feet thick.

Potential Geotechnical Hazards

We have identified three primary geotechnical hazards:

- Long-term settlement of runway embankment soils
- Downhill creep of soft native soils under embankment loading
- Erosion of embankment materials from streams and/or drainage ditches

Both long term settlement and downhill creep can generally be mitigated by excavating the native soils to the bedrock and/or glacial till prior to embankment fill placement. Erosion of the embankment materials may be mitigated through proper ditching, erosion control in the form of rock lining or matting, vegetation, and/or the use of large diameter fill material in the bottom portion of the embankment. These concepts are discussed in more detail in the following sections of this memorandum.

Topic	Discussion
General Site Preparation	<p>During initial site preparation, waste material will be generated in the form of cleared trees, grubbing waste, excavated organics, and other unusable materials. Identifying an appropriate waste disposal site will be a critical step in site preparation. Disposal of the waste on the downhill side from the embankment is a potential solution. Waste materials will likely need some form of containment on the downhill side such as a timber or rock berm that retains the waste materials but allows storm water to flow through. SWPPP best management practices will need to be employed to reduce the potential for water quality impacts from the waste material.</p>
Excavation and Fill	<p>We have identified three options to excavation and backfill:</p> <p>Option 1: Excavate only the organic materials from the runway embankment footprint and leave the native mineral soils in place. In this situation, the embankment would be founded on a variety of foundation conditions which could include bedrock, glacial till, or glacial outwash. While the glacial till is overconsolidated, disturbing the glacial till with heavy equipment and exposing it to excess moisture will likely create a difficult working surface. In areas where the embankment is founded on glacial till or glacial outwash, a subgrade reinforcing geotextile fabric would be recommended. The geotextile and initial lift of embankment fill should be placed as quickly as possible following removal of the organics to reduce disturbance to the existing mineral soils. Depending on the conditions encountered during final subsurface drilling explorations of the chosen alignment, a surcharge and consolidation period may be required in areas where the embankment is founded on fine-grained glacial outwash materials. In areas requiring surcharge and consolidation, settlement plates should be used to monitor the consolidation settlement. Depending on the conditions revealed during drilling of the final alignment, instrumentation, such as inclinometers, may also be recommended during the consolidation period. A surcharge and consolidation period will not be required where the embankment is founded on glacial till or bedrock.</p> <p>Pros:</p> <ul style="list-style-type: none">• Reduced quantities of excavation, runway embankment fill, and waste soil disposal leading to reduced upfront project costs and potential stormwater impacts/challenges. <p>Cons:</p> <ul style="list-style-type: none">• Risk of long term differential settlement and/or instability in fine-grained soils resulting in high maintenance costs.• Longer construction period if a surcharge and consolidation period is required.• Difficult working conditions if fine grained soils are exposed to excessive moisture.• Paving would be delayed until the surcharge and consolidation period is complete.

Topic	Discussion
-------	------------

Option 2: Excavate the surficial organics and glacial outwash materials such that the entire embankment is founded on bedrock or glacial till. A separation geotextile fabric would be recommended where the embankment is founded on glacial till. The separation geotextile fabric and initial lift of embankment fill should be placed as quickly as possible to reduce disturbance of the glacial till.

Pros:

- The entire embankment would be founded on glacial till or bedrock (a stable foundation) reducing the risk of long-term settlement and higher maintenance costs.
- A surcharge and consolidation period would not be required resulting in a shorter construction period and earlier placement of pavement.

Cons:

- Increased quantities of excavation, runway embankment fill, and waste soil disposal resulting in higher upfront construction costs as compared to Option 1.
- Difficult working conditions if the glacial till is exposed to excessive moisture/disturbance.

Option 3:

Although presented here upon discussion with DOT&PF this option was dropped due to high cost and minimal benefit gained.

Excavate all of the soils from the runway embankment footprint, including the glacial till, such that the entire embankment is founded on bedrock. Even though the glacial till is overconsolidated and will provide a good bearing layer for the embankment, disturbing the glacial till and exposing it to excess moisture may create a difficult working surface.

Pros:

- Most stable foundation condition of the three options resulting in the lowest risk of embankment settlement/instability and lower long-term maintenance costs.
- Easier/cleaner working conditions during placement of initial lift of embankment fill.
- No surcharge and consolidation period required.
- No subgrade reinforcing geotextile required.

Cons:

- Highest upfront construction costs as excavation, runway embankment, and waste soil disposal quantities would be the greatest.

Topic	Discussion
	<ul style="list-style-type: none">• Would require the removal of a currently unquantified amount of glacial till which has the potential to serve as a good foundation material.• Excavations may be prohibitively deep, particularly for options Alpha and Charlie.

Considering the variable conditions along each runway alignment alternative, it may be desirable to use some combination of the three options discussed above. Developing an approach that uses a combination of the three options should attempt to balance the upfront construction costs, length of the construction period, timing of pavement placement, and long-term maintenance costs.

Discussion of Quantities

Using ArcGIS, a centerline cut was taken through surfaces created from the probing data along the centerline of each alignment to observe the thickness of surficial organics across each alignment. A plot of the ground surface, bottom of organics surface, and the probe refusal surface for each alignment is attached to this memorandum. Please note that the probe refusal surface does not identify the type of material encountered at refusal and may still be in organic soils where the maximum reach of the probe was met. Using the data presented in the attached plots, the average organic depth along the centerline of each alignment is as follows:

- Alpha: 2.2 feet
- Charlie: 2.7 feet
- Echo: 1.5 feet

While these represent average quantities, it should be noted that there are several areas of significantly deeper organic deposits. Noted below are several observations regarding variability of the organic deposits along each alignment:

- Alpha Alignment North of the stream crossing. The ground surface is generally undulating in this area and there are two primary areas of deeper organic deposits with average depths of approximately five feet at the northernmost area and approximately eight feet at the more southern area. Near the stream crossing, approximately 350 feet of the alignment has an organic depth of approximately 3.5 feet.
- Charlie Alignment North of the Southfork stream crossing. Approximately 1200 feet of the alignment has an average of 6 feet of organic deposits with maximum depths unknown due to the limitation of the probe length of nine feet during field work.
- The Echo alignment generally has the shallowest organic deposits with only a few areas with organics thicker than the average thickness of 1.5 feet.

Using the hand probe data, we estimated the quantities presented in Table 1 of this memorandum for excavation and fill Options 1 and 2. For Option 2, we assumed that excavation would extend to the probe refusal elevations. In reality, excavating to bedrock and/or glacial till may require a deeper excavation than the depth indicated by

Topic	Discussion
-------	------------

probe refusal in some areas. However, the data is still useful in comparing the relative quantities of the three runway alignment alternatives. The quantities presented in Table 1 do not account for any excavations required for airspace purposes – only for placement of the embankment. We anticipate that some useable material will be generated by the excavations required for airspace purposes.

Table 1: Excavation and Embankment Fill Estimates

Runway Alignment Alternative	Option 1 - Excavate Organics Only		Option 2 - Excavate to Probe Refusal	
	Total Excavation (CY)	Total Embankment Fill (CY)	Total Excavation (CY)	Total Embankment Fill (CY)
Alpha	207,500	720,940	279,320	792,760
Charlie	174,900	483,380	239,810	548,290
Echo	135,100	268,320	187,700	320,920

Material Availability	Three potential alternatives for material borrow sites have been identified near the project site:
------------------------------	----------------------------------------------------------------------------------------------------

- A high area near the north end of the project site which has been referred to in discussions as the “Knob”. The Knob rises to an elevation of approximately 170 feet. A small bedrock outcropping was observed at the peak of the Knob. Drilling and laboratory testing would be required to evaluate the quality of the material available in the Knob. Probing on the Knob indicated that bedrock is generally approximately 0.5 to 3.5 feet below the ground surface. Based on a final excavation elevation of approximately 113 feet, we estimate that there is approximately 420,000 CY of useable material at the Knob. This potential material source is on the project site and provides the shortest haul route without royalties associated with extracting the material.
- Existing borrow pit owned by Sealaska located near the north end of the project site on the northeast side of the BIA road. The rock material appeared more weathered and more fractured than the rock outcropping observed on the Knob. The rock available at this site would likely be of high enough quality for common borrow material. Laboratory testing would be required to evaluate the quality of the material for other uses such as base course, leveling course, or asphalt pavement aggregate. The available quantity of rock will depend on the amount of land Sealaska has access to. We do not currently know what royalties would be associated with extracting material from this site.. While not located on the project site, this material source provides a very short haul route as it is located immediately across the BIA road from the project site. Immediately to the southeast of the Sealaska borrow pit, a ridge that is approximately 0.5 miles long rises to an elevation of approximately 240 feet. This ridge is the same formation the Sealaska borrow pit is located in and has the potential to provide a large quantity of useable material. Land ownership in this area may complicate access and availability.
- Along the BIA road between the Sealaska borrow pit and the City of Angoon Water Treatment facility, several high ridge areas with rock outcroppings visible

Topic	Discussion
	<p>on the uphill side of the BIA road were identified. These areas would require a farther haul distance than the Knob or the existing Sealaska pit. The rock outcroppings we observed from the BIA road are located approximately 1.5 miles southeast of the existing Sealaska borrow pit. Land ownership in this area may needs to be researched to evaluate access and availability.</p> <p>Until the quality of the locally available materials has been evaluated, planning level cost estimates should consider the following two scenarios:</p> <ul style="list-style-type: none">• Assume that the locally available materials are not of high enough quality for pavement aggregates and subbase so these materials will need to be imported.• Assume that the locally available materials are of high enough quality for pavement aggregates and subbase and no earth materials will need to be imported.
Embankment Stability	<p>Traditionally, 4H:1V fill slopes have been used for runway embankments. Current preliminary design concepts utilize 3H:1V fill slopes. The current preliminary design concepts of 3H:1V slopes are appropriate for the runway embankment. If the runway embankment is founded on only bedrock and/or glacial till; the embankment fill is comprised well graded, angular, granular materials (typical of shot rock fills); and the backfill is properly compacted, steeper slopes (possibly as steep as 2H:1V) may be acceptable.</p> <p>If the excavation and backfill Option 1 is chosen, the embankment slopes may need to be regraded (depending on the level of deformation experienced during surcharge) following the surcharge and consolidation period.</p> <p>For ditching on the uphill side of the embankment, 3H:1V slopes are appropriate for ditching in mineral soils. Any ditching required in the saturated organics will require very flat cut slopes to be stable. Any ditching will require erosion control measures such as rock lining or matting. If the bottom few feet of the embankment is constructed of large diameter (12 to 24 inches) porous backfill, the need for ditching may be reduced or eliminated (see discussion below).</p>
Groundwater Hydraulic Issues	<p>Due to saturated organics, excavation will be difficult in the low lying wet boggy areas. Dewatering will likely be required during excavation in these areas. Because of the saturated organic soils, a viable dewatering alternative may consist of ditching around the perimeter of the excavations and directing the water to low lying areas and/or sump pump locations as appropriate. Any ditching in the saturated organics will require very flat cut slopes to be stable. The water quality of the discharge from dewatering efforts may be improved through the use of a flocculant and settling ponds as was successfully implemented by DOT at the Petersburg Airport. Of the three alignment alternatives, The Charlie alternative presents the greatest challenge for excavation of saturated organic materials in terms of total quantity, followed by Alpha, and finally Echo.</p>

Topic	Discussion
	<p>If the embankment is constructed such that the bottom few feet of the embankment is constructed of large particle sizes (12 to 24-inch diameter material), this will allow water to flow through the embankment and seep back into the subsurface downhill of the embankment. This will eliminate concerns of erosion at the toe of the uphill side of the embankment and significantly reduce the amount of surface water that must be handled on the uphill side of the embankment. This will also reduce the amount of crushing that is required to produce the embankment materials and the amount of compaction effort required during placement of the embankment material. This approach will require that subsequent layers of fill are graded such that the overlying layers do not penetrate into the more porous underlying layers. If this approach is chosen, careful consideration will need to be given to the topography of the chosen alignment and provisions would need to be included in the design to prevent water from ponding underneath the embankment fill.</p>

Probe Surfaces - Alpha Alignment

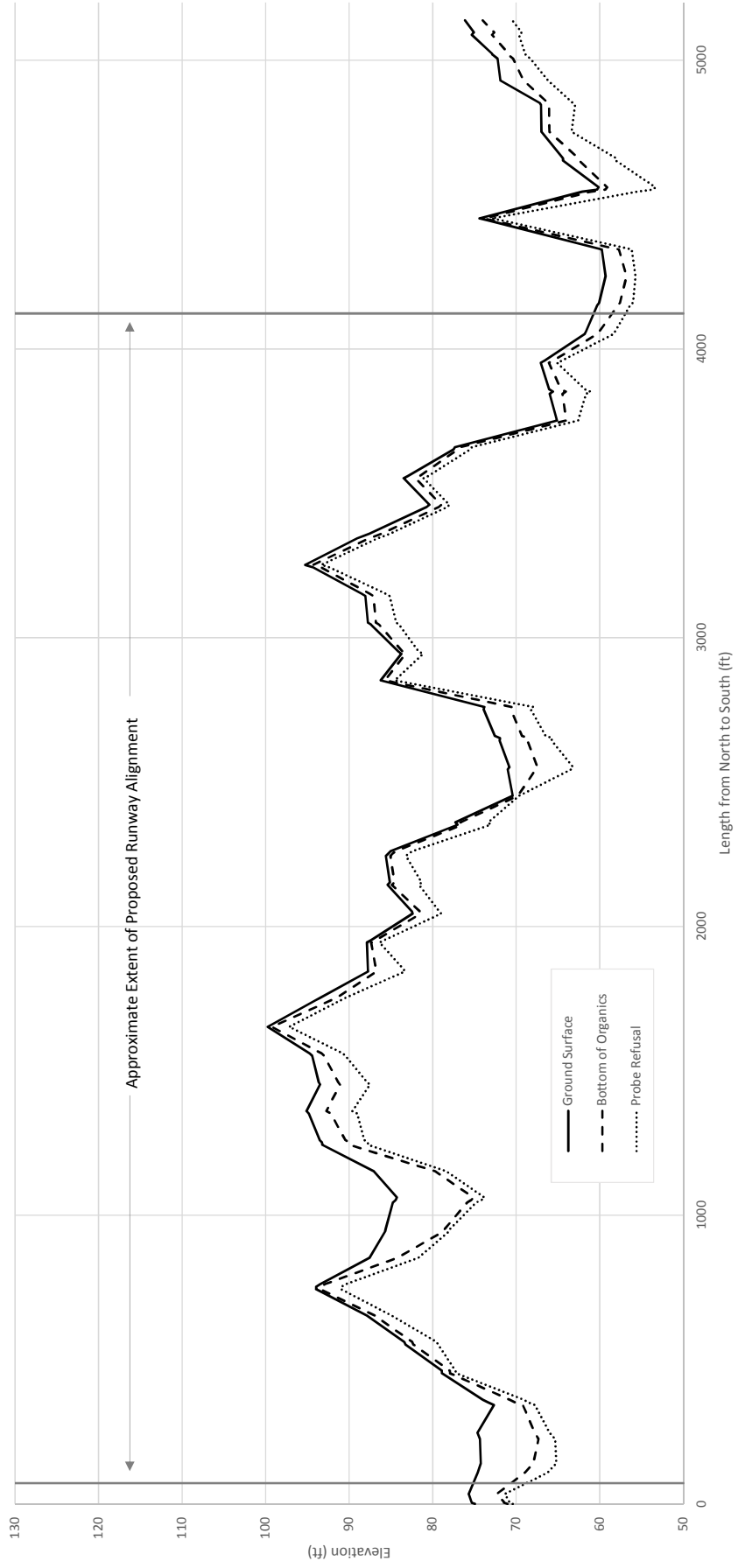

Probe Surfaces - Charlie Alignment

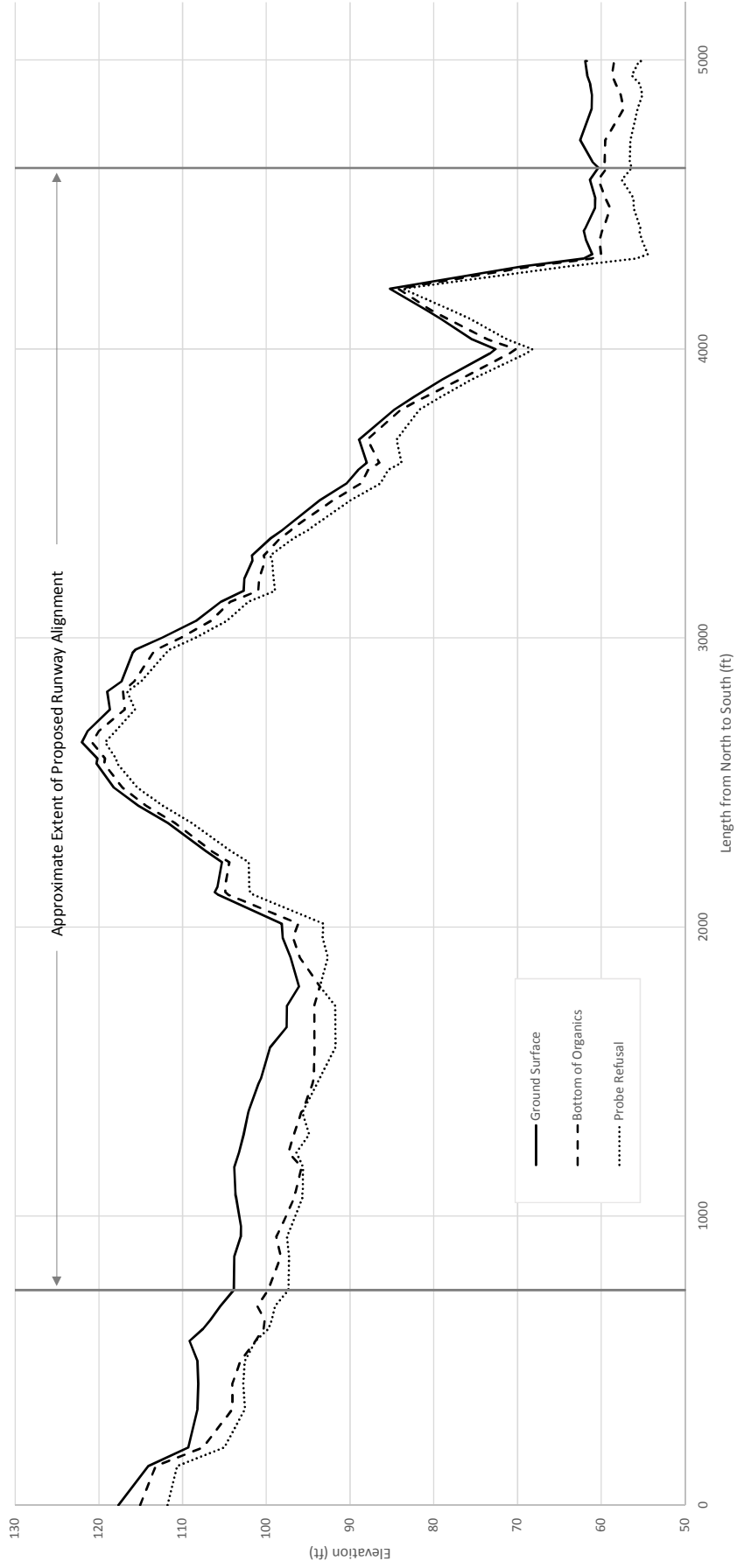

Probe Surfaces - Echo Alignment

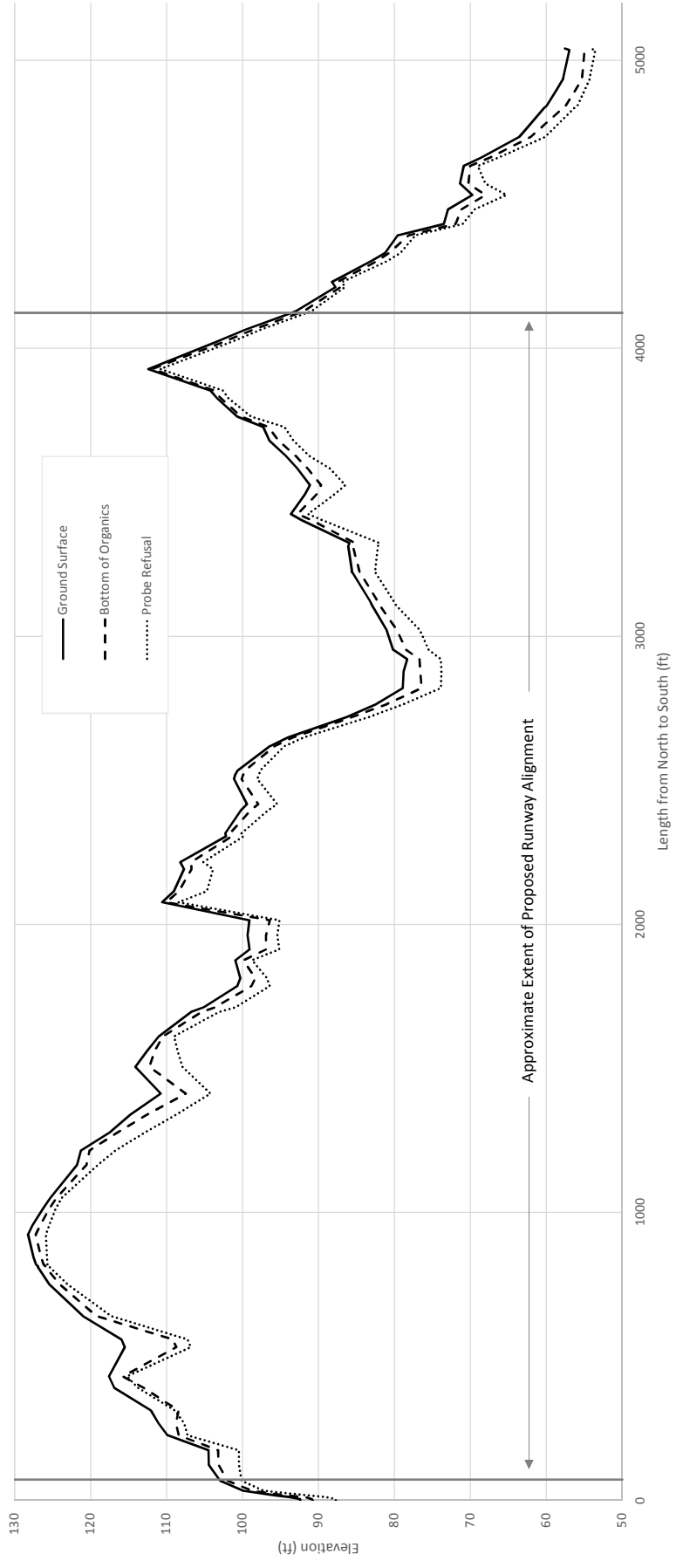



APPENDIX G

COST ESTIMATE

**ANGOON AIRPORT
PRELIMINARY CONSTRUCTION COST ESTIMATE -- 15% Design**

Item #	Description	Unit	Quantity	Unit Price	Total
D-701a-(1)	Corrugated Polyethylene Pipe, 24-Inch	Linear Foot	200	\$200.00	\$40,000.00
D-701a-(2)	Corrugated Polyethylene Pipe, 36-Inch	Linear Foot	150	\$225.00	\$33,750.00
D-701a-(3)	Fish Passage Bottomless Arch Culvert	Linear Foot	250	\$4,000.00	\$1,000,000.00
F-162a	8-Foot Chain Link Fence	Linear Foot	16,100	\$75.00	\$1,207,500.00
G-100a	Mobilization and Demobilization	Lump Sum	1	\$2,950,000.00	\$2,950,000.00
G-115a	Worker Meals and Lodging, or Per Diem	Lump Sum	1	\$1,350,000.00	\$1,350,000.00
G-130a	Field Office	Lump Sum	1	\$40,000.00	\$40,000.00
G-130b	Field Laboratory	Lump Sum	1	\$45,000.00	\$45,000.00
G-130g	Nuclear Testing Equipment Storage Shed	Each	1	\$5,000.00	\$5,000.00
G-131a	Engineering Transportation (Truck)	Each	2	\$25,000.00	\$50,000.00
G-131b	Engineering Transportation (ATV)	Each	1	\$14,000.00	\$14,000.00
G-135a	Construction Surveying by the Contractor	Lump Sum	1	\$100,000.00	\$100,000.00
G-135b	Extra Three Person Survey Party	Hour	50	\$300.00	\$15,000.00
G-150a	Equipment Rental, Dozer (Minimum 70 HP)	Hour	70	\$200.00	\$14,000.00
G-710d	Highway Traffic Control	Contingent Sum	1	\$30,000.00	\$30,000.00
L-100	Airport Lighting	Lump Sum	1	\$744,100.00	\$744,100.00
L-132	Install Approach Lighting Aids (PAPI)	Each	1	\$40,000	\$40,000.00
L-132	Install Approach Lighting Aids (REILs)	Each	2	\$30,000	\$60,000.00
P-151	Clearing	Acres	154	\$3,000	\$462,600.00
P-151	Selected Tree Removal	Each	4,648	\$300	\$1,394,400.00
P-152a	Unclassified Excavation	Cubic Yard	357,500	\$10	\$3,575,000.00
P-152c	Muck Excavation	Cubic Yard	351,800	\$18	\$6,332,400.00
P-152h	Borrow Measured in Final Position/ Embankment	Cubic Yard	0	\$10.00	\$0.00
P-152ai	Ditch Lining/ Ditch linear Grading	Cubic Yard	1,400	\$40.00	\$56,000.00
P-154a	Subbase Course	Cubic Yard	101,400	\$17.00	\$1,723,800.00
P-157	Erosion, Sediment, and Pollution Control	Lump Sum	1	\$700,000.00	\$700,000.00
P-180	Riprap, Class II	Cubic Yard	500	\$65.00	\$32,500.00
P-209	Crushed Aggregate Base Course	Cubic Yard	12,700	\$30.00	\$381,000.00
P-401	Hot Mix Asphalt	Ton	19,500	\$150.00	\$2,925,000.00
P-401	Asphalt Cement (6%)	Ton	1,200	\$950.00	\$1,140,000.00
P-401	Asphalt Price Adjustment (5% of HMA+AC)	Contingent Sum	1	\$203,250.00	\$203,250.00
P-603	Tack Coat	Ton	40	\$1,000.00	\$40,000.00
P-620	Runway and Taxiway Markings	Lump Sum	1	\$200,000.00	\$200,000.00
P-640b	Segmented Circle (Panel-Type)	Lump Sum	1	\$100,000.00	\$100,000.00
P-650a	Aircraft Tie-Down	Each	3	\$3,500.00	\$10,500.00
P-661a	Standard Sign	Square Foot	100	\$175.00	\$17,500.00
P-681a	Geotextile, Separation	Square Yard	69,500	\$3.00	\$208,500.00
S-142p	Equipment Storage Building No. 1, Heated	Lump Sum	1	\$1,852,900.00	\$1,852,900.00
T-901h	Seeding	Lump Sum	1	\$105,000.00	\$105,000.00
T-908n	Hydraulic Erosion Control Product (HECP)	Square Yard	169,500	\$2.00	\$339,000.00
U-500b	Electrical Line Extension	Lump Sum	1	\$125,000.00	\$125,000.00

Subtotal	\$29,662,700.00
Preconstruction Contingency @ 20%	\$5,932,540.00
Construction Admin @ 15%	\$4,449,405.00
Subtotal	\$40,044,645.00
4.23% ICAP	\$1,693,888.48
Project Construction Total	\$41,738,533.48

ROW Acquisition	\$18,000,000.00
Environmental Permitting and Mitigation	\$8,000,000.00

Project Total	\$67,738,533.48
----------------------	------------------------

